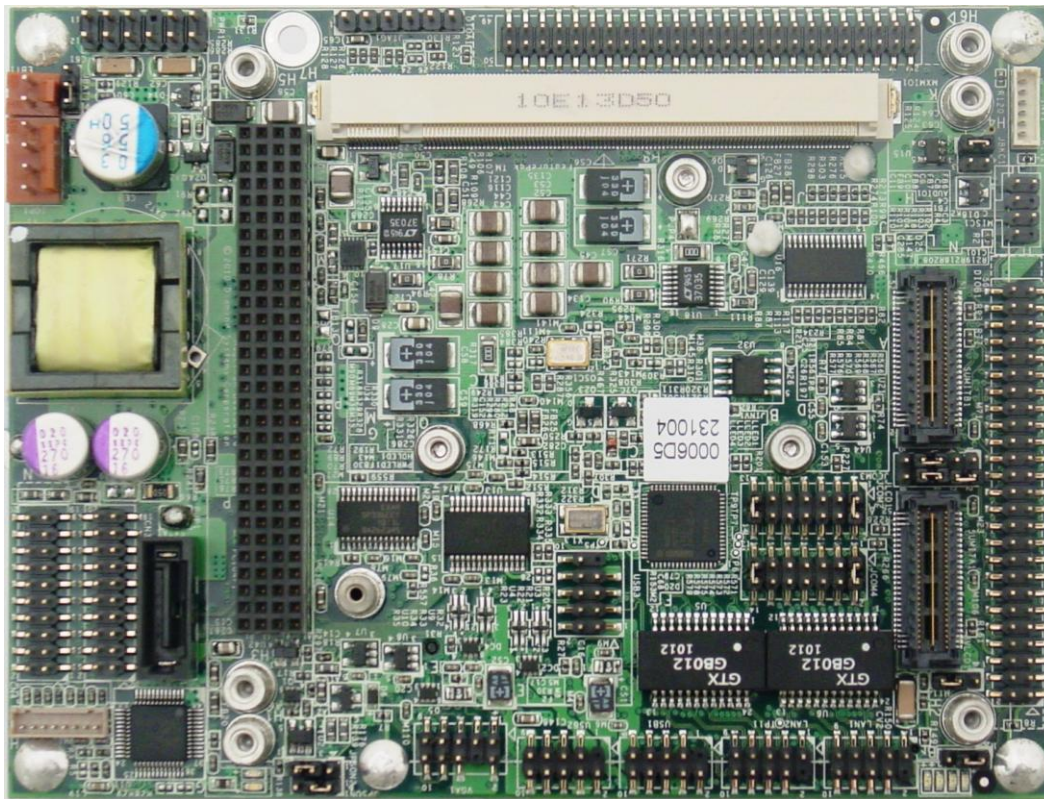




# MAGELLAN Single Board Computer

COM Express™ Form-Factor Embedded-Ready  
Subsystem with configurable COM CPU



| Revision | Date     | Comment                          |
|----------|----------|----------------------------------|
| A.00     | 12/9/10  | Initial Release                  |
| A.01     | 6/23/11  | Added MAG-965-xG models          |
| A.02     | 11/18/13 | Added FeaturePak pinout Appendix |

**FOR TECHNICAL SUPPORT  
PLEASE CONTACT:**

[support@diamondsystems.com](mailto:support@diamondsystems.com)

© Copyright 2013  
Diamond Systems Corporation  
555 Ellis Street  
Mountain View, CA 94043 USA  
Tel 1-650-810-2500  
Fax 1-650-810-2525  
[www.diamondsystems.com](http://www.diamondsystems.com)

# CONTENTS

|   |           |
|---|-----------|
| <b>Important Safe-Handling Information .....</b>                        | <b>4</b>  |
| <b>1. Introduction .....</b>  | <b>5</b>  |
| 1.1 Magellan Features .....   | 6         |
| 1.2 FeaturePak and SUMIT Socket Resources .....                         | 7         |
| 1.3 Software Compatibility .....  | 7         |
| 1.4 Thermal Considerations and Heatspreader .....                       | 7         |
| <b>2. Functional Overview .....</b>                                     | <b>8</b>  |
| 2.1 Block Diagrams .....  | 8         |
| 2.2 Magellan Baseboard Dimensions .....                                 | 10        |
| 2.3 Baseboard Connector Locations .....                                 | 11        |
| 2.3.1 Connector Summary .....   | 12        |
| 2.4 Baseboard Configuration Jumpers .....                               | 13        |
| 2.4.1 Configuration Jumper Summary .....                                | 14        |
| <b>3. Getting Started .....</b>   | <b>14</b> |
| 3.1 Introducing the Magellan Development Kit .....                      | 15        |
| 3.1.1 Magellan Cable Kit .....  | 16        |
| 3.2 System Setup .....  | 17        |
| 3.2.1 Display .....   | 17        |
| 3.2.2 Keyboard and Mouse .....  | 17        |
| 3.2.3 USB Flashdisk Socket .....  | 17        |
| 3.2.4 Mass Storage Devices .....  | 17        |
| 3.2.5 Connecting Power .....  | 17        |
| 3.2.6 Installing Magellan in an Enclosure (optional) .....              | 17        |
| 3.3 Booting the System .....  | 18        |
| 3.3.1 BIOS Setup .....  | 18        |
| 3.3.2 Operating System Drivers .....                                    | 18        |
| <b>4. Interface Connector Details .....</b>                             | <b>19</b> |
| 4.1 Audio Output (AUDIO1) .....   | 19        |
| 4.2 Serial Ports (CN3, CN4) .....                                       | 19        |
| 4.3 Auxiliary Power Output (IOP1) .....                                 | 21        |
| 4.4 External Battery Input (EBT1) .....                                 | 21        |
| 4.5 Input Power (PWR1) .....  | 21        |
| 4.6 PCI-104 (PCI) Expansion Bus (PC104P1) .....                         | 22        |
| 4.7 JTAG Interface (JTAG1) .....  | 23        |
| 4.8 FeaturePak Expansion Socket (MXMIO1) .....                          | 23        |
| 4.9 I/O Connectors A and B (DIOA1, DIOB1) .....                         | 25        |
| 4.10 LCD Backlight (INV1) .....   | 25        |
| 4.11 Auxiliary Signals Connector (MISC1) .....                          | 25        |
| 4.12 SUMIT Expansion Bus (SUMITA1, SUMITB1) .....                       | 26        |
| 4.13 Gigabit Ethernet (LAN1, LAN2) .....                                | 27        |
| 4.14 USB Ports 0-3 (USB1, USB2) .....                                   | 27        |
| 4.15 USB Flash Module Socket (USB3) .....                               | 27        |
| 4.16 VGA (VGA1) .....   | 28        |
| 4.17 SATA (SATA1) .....   | 28        |
| 4.18 LCD Panel Interface (LVDS1) .....                                  | 29        |
| <b>5. Configuration Jumper Details .....</b>                            | <b>30</b> |
| 5.1 External CMOS/RTC Backup Battery Enable (JBAT1) .....               | 30        |
| 5.2 LCD Backlight Brightness Control Selection (JBKC1) .....            | 30        |
| 5.3 LCD panel signal control (JLCD1) .....                              | 31        |
| 5.4 LCD panel power select (JVLCD1) .....                               | 31        |
| 5.5 LCD backlight inverter power select (JINV1) .....                   | 31        |
| 5.6 Serial port COM3 mode select (JCOM3) .....                          | 32        |
| 5.7 Serial port COM4 mode select (JCOM4) .....                          | 33        |
| 5.8 Serial port signals to MXM or Supper I/O (JCOM2) .....              | 33        |
| 5.9 On-board Power Supply Power-up/down Behavior (JPSON1, JPSON2) ..... | 34        |
| <b>6. BIOS .....</b>  | <b>35</b> |
| 6.1 BIOS Functions .....  | 35        |
| 6.2 Entering the BIOS .....   | 35        |
| 6.3 Storing Default BIOS Settings .....                                 | 35        |

---

|            |                                 |           |
|------------|---------------------------------|-----------|
| 6.4        | Setting the Date and Time.....  | 35        |
| 6.5        | ISA Bus IRQ Selection .....     | 35        |
| 6.6        | Boot Menu .....                 | 35        |
| 6.7        | Chipset.....                    | 36        |
| 6.8        | Super I/O Configuration.....    | 36        |
| 6.9        | Console Redirection .....       | 36        |
| 6.10       | Power Type Select.....          | 36        |
| 6.11       | Boot Delay .....                | 36        |
| 6.12       | Saving the Changes .....        | 36        |
| <b>7.</b>  | <b>Watchdog Timer.....</b>      | <b>37</b> |
| 7.1        | Registers.....                  | 37        |
| 7.2        | Programming Sample Code .....   | 38        |
| <b>8.</b>  | <b>Accessories.....</b>         | <b>39</b> |
| 8.1        | Thermal Pad .....               | 39        |
| 8.2        | PC/104 Hardware Kit.....        | 39        |
| <b>9.</b>  | <b>Specifications.....</b>      | <b>40</b> |
| <b>10.</b> | <b>Appendix A.....</b>          | <b>41</b> |
| 10.1       | FP-DAQ1616 Pinout.....          | 41        |
| 10.1.1     | DIOA1: Analog I/O Signals ..... | 41        |
| 10.1.2     | DIOD1: Digital I/O Signals..... | 42        |
| 10.2       | FP-GPIO96 Pinout.....           | 43        |
| 10.2.1     | DIOA1 .....                     | 43        |
| 10.2.2     | DIOD1 .....                     | 44        |

## IMPORTANT SAFE-HANDLING INFORMATION



### **WARNING: ESD-Sensitive Electronic Equipment!**

**Observe ESD-safe handling procedures when working with this product.**

**Always use this product in a properly grounded work area and wear appropriate ESD-preventive clothing and/or accessories.**

**Always store this product in ESD-protective packaging when not in use.**

### ***Safe Handling Precautions***

Magellan contains numerous I/O connectors that connect to sensitive electronic components. This creates many opportunities for accidental damage during handling, installation and connection to other equipment. The list here describes common causes of failure found on boards returned to Diamond Systems for repair. This information is provided as a source of advice to help you prevent damaging your Diamond (or any vendor's) embedded computer boards.

**ESD damage** – This type of damage is almost impossible to detect, because there is no visual sign of failure or damage. The symptom is that the board simply stops working, because some component becomes defective. Usually the failure can be identified and the chip can be replaced.

To prevent ESD damage, always follow proper ESD-prevention practices when handling computer boards.

**Damage during handling or storage** – On some boards we have noticed physical damage from mishandling. A common observation is that a screwdriver slipped while installing the board, causing a gouge in the PCB surface and cutting signal traces or damaging components.

Another common observation is damaged board corners, indicating the board was dropped. This may or may not cause damage to the circuitry, depending on what is near the corner. Most of our boards are designed with at least 25 mils clearance between the board edge and any component pad, and ground / power planes are at least 20 mils from the edge to avoid possible shorting from this type of damage. However these design rules are not sufficient to prevent damage in all situations.

A third cause of failure is when a metal screwdriver tip slips, or a screw drops onto the board while it is powered on, causing a short between a power pin and a signal pin on a component. This can cause overvoltage / power supply problems described below. To avoid this type of failure, only perform assembly operations when the system is powered off.

Sometimes boards are stored in racks with slots that grip the edge of the board. This is a common practice for board manufacturers. However our boards are generally very dense, and if the board has components very close to the board edge, they can be damaged or even knocked off the board when the board tilts back in the rack. Diamond recommends that all our boards be stored only in individual ESD-safe packaging. If multiple boards are stored together, they should be contained in bins with dividers between boards. Do not pile boards on top of each other or cram too many boards into a small location. This can cause damage to connector pins or fragile components.

**Power supply wired backwards** – Our power supplies and boards are not designed to withstand a reverse power supply connection. This will destroy each IC that is connected to the power supply. In this case the board will most likely will be unrepairable and must be replaced. A chip destroyed by reverse power or by excessive power will often have a visible hole on the top or show some deformation on the top surface due to vaporization inside the package. **Check twice before applying power!**

**Bent connector pins** – This type of problem is often only a cosmetic issue and is easily fixed by bending the pins back to their proper shape one at a time with needle-nose pliers. This situation can occur when pulling a ribbon cable off of a pin header. Note: If the pins are bent too severely, bending them back can cause them to weaken unacceptably or even break, and the connector must be replaced.

# 1. INTRODUCTION

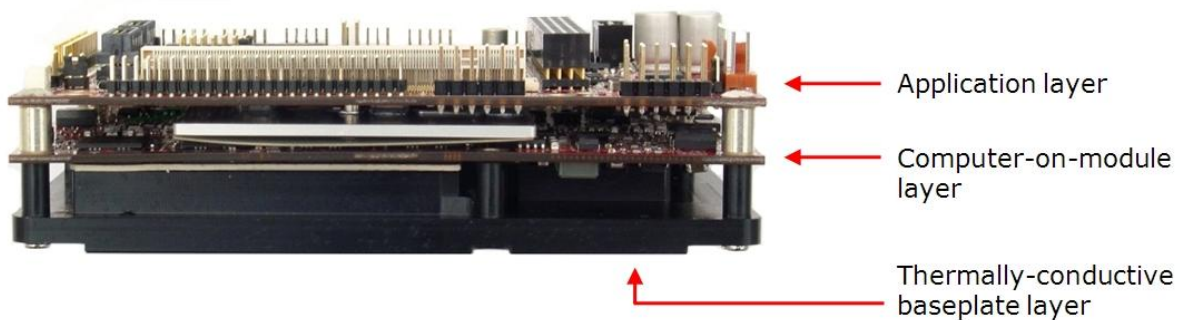
The Magellan Embedded-Ready Subsystem is a high performance, highly integrated board-level embedded single board computer matching the footprint of the popular COM Express computer-on-module (COM) standard.

Magellan’s CPU core consists of a COM Express CPU module mounted on its bottom side, an approach that improves thermal management and increases the space for I/O functions and connectors. This innovative design has enabled Magellan to integrate additional serial and Ethernet controllers, a complete set of peripheral interface header connectors, a PCI-104™ expansion stack, SUMIT™ bus connector, and a MXM I/O FeaturePak™ socket all within the compact COM Express footprint.

Thanks to Magellan’s flexible architecture, you can select from a wide range of COM Express-based CPUs to meet each application’s specific performance, power, and cost requirements. Available processors include Intel’s Atom and Core 2 Duo CPUs.

Magellan is offered in a range of models that vary according to the choice of COM Express CPU module, on-board SO-DIMM SDRAM capacity, and input power option as shown in the table below.

| <i>Magellan Model</i> | <i>COM Express CPU Module</i> | <i>Processor Type</i> | <i>Processor Clock</i> | <i>RAM</i>         | <i>Input Power</i> |
|-----------------------|-------------------------------|-----------------------|------------------------|--------------------|--------------------|
| MAG-965-4G            | CME-965-L7500                 | Intel Core 2 Duo LV   | 1.6GHz                 | 4GB SO-DIMM SDRAM  | +7-36VDC input     |
| MAG-965-1G            | CME-965-L7500                 | Intel Core 2 Duo LV   | 1.6GHz                 | 1GB SO-DIMM SDRAM  | +7-36VDC input     |
| MAG-965LC-4G          | CME-965-L7500                 | Intel Core 2 Duo LV   | 1.6GHz                 | 4GB SO-DIMM SDRAM  | +12VDC only        |
| MAG-965LC-1G          | CME-965-L7500                 | Intel Core 2 Duo LV   | 1.6GHz                 | 1GB SO-DIMM SDRAM  | +12VDC only        |
| MAG-Z510-1G           | CME-Z510-1G                   | Intel Atom Z510       | 1.1GHz                 | 1GB soldered SDRAM | +7-36VDC input     |
| MAG-Z510LC-1G         | CME-Z510-1G                   | Intel Atom Z510       | 1.1GHz                 | 1GB soldered SDRAM | +12VDC only        |



**Figure 1: Edge View of the Magellan Embedded-Ready Subsystem SBC**

Magellan’s features comprise functions provided by the “Magellan baseboard”, or application layer, (top board in stack shown in Figure 1) along with functions implemented on the attached COM Express computer-on-module (COM) macrocomponent (bottom board in stack), along with a heatspreader mounted on the bottom.

These features are summarized on the next page.



## 1.1 Magellan Features

**Note:** The COM Express COM features listed here are typical. Refer to the appropriate COM Express CPU module's user manual for detailed specifications.

- CPU: choice of two COM Express CPU modules
  - 1.1GHz Intel Atom Z510, using the CME-Z510-1G COM Express CPU module
  - 1.6GHz Intel Core 2 Duo LV, using the CME-965-L7500 COM Express CPU module
- RAM
  - Atom Z510: 1GB of DDR2 SDRAM soldered on-board
  - Core 2 Duo LV: 1GB or 4GB SO-DIMM DDR2 SDRAM
- Chipset
  - Atom Z510: US15WPT
  - Core 2 Duo LV: 965GME with ICH8M
- BIOS: AMI PnP Flash BIOS
- Storage
  - One SATA port supports one device
  - On-board USB flashdisk socket
- Serial Ports:
  - Two RS-232 serial ports
  - Two RS-232/422/485 serial ports
- Four USB 2.0 ports
- Networking:
  - 1 gigabit Ethernet from COM CPU
  - 1 gigabit Ethernet from Intel 82574 controller on baseboard
- Display:
  - LVDS LCD flat panel interface  
Diamond supports Sharp LQ121S1LG41 and LQ121S1LG42 flat panels
  - VGA CRT
- USB keyboard and mouse
- Audio: AC'97 audio CODEC; mic in, line in/out
- Watchdog timer: Non-maskable interrupt or reset modes
- Other I/O: SMBus; LPC interface
- Expansion buses:
  - PCI-104 or SUMIT bus connector stackable expansion (see below)
  - FeaturePak™ socket ( see below)
- Power
  - Power input: +7-36VDC or +12VDC only (LC models)
  - On-board power supply: Built-in +7-36V DC/DC power supply
  - On-board RTC backup battery; connector for external battery
- Operating environment:
  - Temperature MAG-965-xG models: -40°C to +80° (-40°F to +176°F)  
All other models: -40°C to +85° (-40°F to +185°F)
  - Humidity: 0-90% non-condensing
- Dimensions:
  - MAG-Z510-1G: 4.9 x 3.7 x 1.77 in. (125 x 95 x 45 mm)
  - MAG-965 models: 4.9 x 3.7 x 2.24 in (125 x 95 x 57 mm)
- Weight:
  - MAG-Z510-1G: 11.7oz (332g)
  - MAG-965 models: 19.2oz (544g)
- Form-factor: COM Express footprint (4.92 x 3.74 in.)

## 1.2 FeaturePak and SUMIT Socket Resources

Magellan's FeaturePak and SUMIT expansion sockets provide the host interface resource support indicated in the tables below. For further details on these expansion standards, visit [FeaturePak.org](http://FeaturePak.org) and [SFF-SIG.org/sumit.html](http://SFF-SIG.org/sumit.html).

| SUMIT Resources  |         |         |
|--|---------|---------|
| <b>Company:</b> Diamond Systems Corp.  |         |         |
| <b>Product:</b> Magellan baseboard   |         |         |
| <b>Form-factor:</b> COM Express footprint  |         |         |
|  | SUMIT A | SUMIT B |
| <b>PCIe x1</b>   | 1       | 2       |
| <b>PCIe x4</b>   |         | -       |
| <b>USB</b>   | 1       |         |
| <b>ExpressCard</b>   | -       |         |
| <b>LPC</b>   | √       |         |
| <b>SPI /uWire</b>  | -       |         |
| <b>SMBus or I2C</b>  | SMBus   |         |
| <b>+12V</b>  | √       |         |
| <b>+5V</b>   | √       | √       |
| <b>+5Vsb</b>   | √       | √       |
| <b>+3.3V</b>   | √       | √       |
| Notes:<br><a href="http://www.sff-sig.org/sumitlabel.html">www.sff-sig.org/sumitlabel.html</a> |         |         |

| FeaturePak™<br>Socket Resources  |           |
|--|-----------|
| <b>Company:</b> Diamond Systems Corp.  |           |
| <b>Product:</b> Magellan Baseboard   |           |
| Host Interface Resources Supported   |           |
| <b>PCIe x1 links</b>   | 2         |
| <b>USB channels</b>  | 2 USB 2.0 |
| <b>Serial port</b>   | opt.      |
| <b>SMBus</b>   | √         |
| <b>PCIe Reset</b>  | √         |
| <b>Sys Reset</b>   | √         |
| <b>JTAG</b>  | √         |
| <b>+3.3V</b>   | √         |
| <b>+5V</b>   | √         |
| <b>+12V</b>  | √         |
| Notes:<br><a href="http://www.featurepak.org/label">www.featurepak.org/label</a> |           |

## 1.3 Software Compatibility

Magellan's operating system compatibility is a function of both the Magellan baseboard and the specific COM Express CPU module attached to it. The baseboard and has been qualified for use with Windows XP/XPe and Linux 2.6. The operating systems supported by the COM Express CPU module vary according to the specific COM Express module used. Consult the appropriate COM Express CPU module's user manual for details on its operating system support.

## 1.4 Thermal Considerations and Heatspreader

All models of Magellan are specified for an operating temperature range of -40°C to +85°C. Diamond Systems provides a heatspreader attached to the Magellan single board computer as a conductive cooled thermal layer. However, this heatspreader by itself does not constitute the complete thermal solution necessary for any specific implementation, but provides a common interface between the single board computer and the customer's implementation-specific thermal solution.

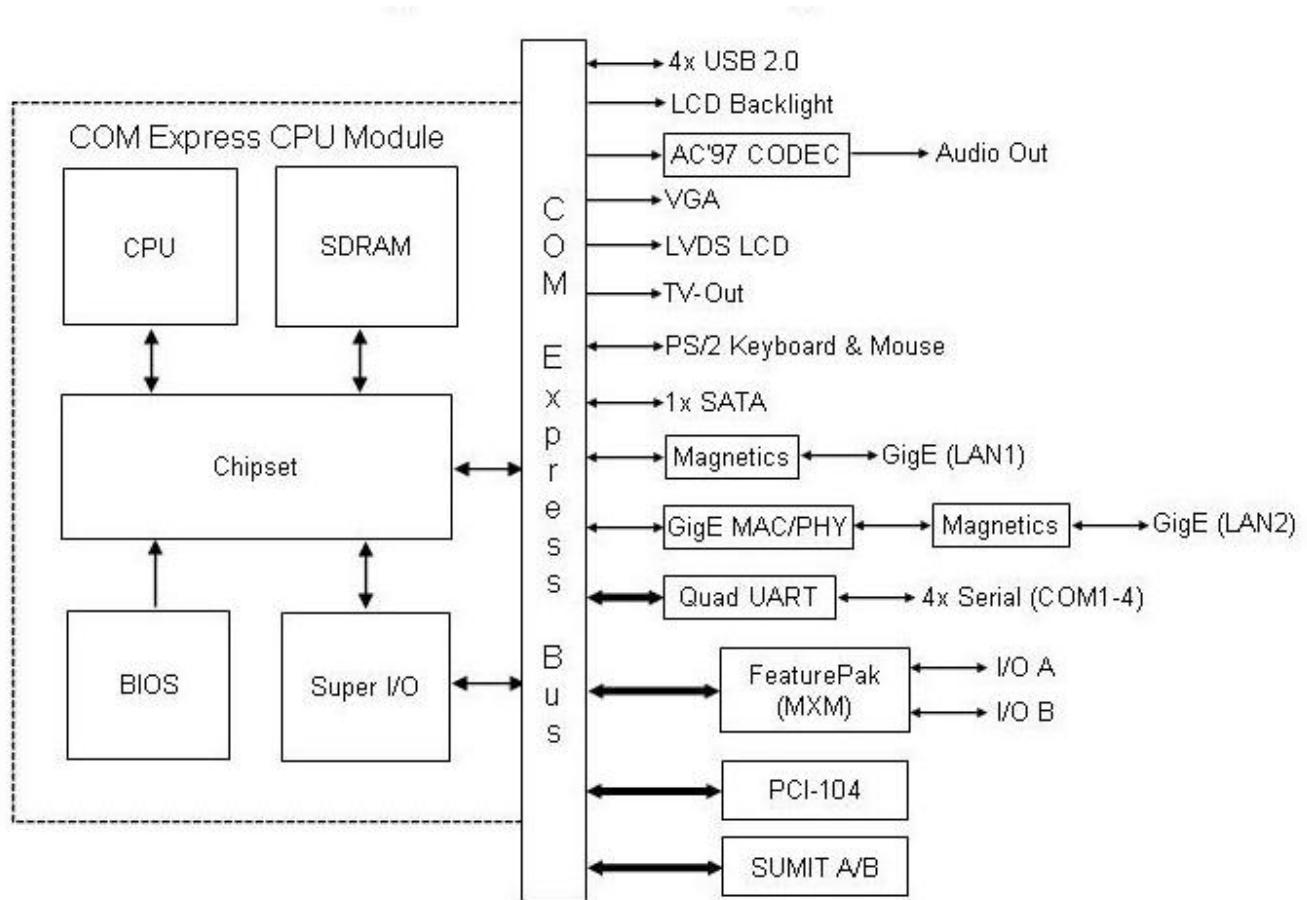
For Magellan MAG-965 models, the heatspreader is only a partial thermal solution. To achieve the full -40°C to +85°C operating range with these models, the outside surface of the Magellan MAG-965 heatspreader must be kept at a temperature not to exceed +85°C. If your environment exceeds this temperature specification, you are responsible for removing the additional heat from the system through either an additional passive thermal solution or fan solution.

Magellan's integrated heatspreader makes thermal contact with the heat generating components and provides a flat surface on the bottom of the assembly for mating to the system enclosure. This technique facilitates efficient removal of heat from the COM module without the need for a fan. Four mounting holes on the bottom of the conduction cooled heatspreader are provided to mount Magellan in an enclosure or to a bulkhead. These mounting holes are #6-32 threaded holes on 2.8" centers.

## 2. FUNCTIONAL OVERVIEW

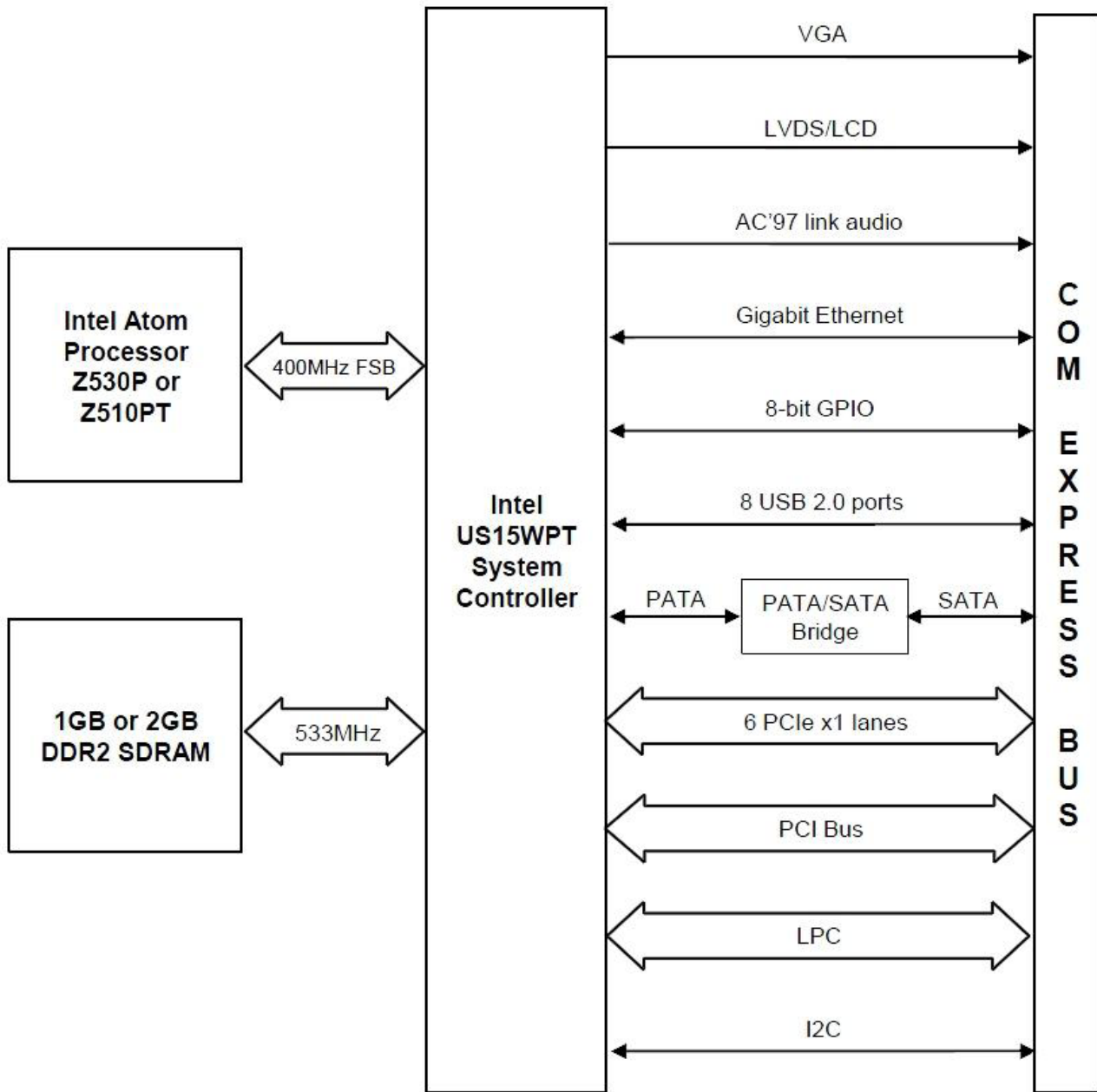
### 2.1 Block Diagrams

Figure 2 illustrates Magellan’s functional blocks, including circuitry contained on both the Magellan baseboard and the COM Express CPU module. As indicated in the block diagram, the baseboard circuitry primarily comprises interface connections and additional LAN and serial I/O, while the COM Express module integrates the system’s core embedded PC functionality. Although COM Express CPU module processors and precise functions vary between specific modules, the block diagram of a typical COM Express CPU module appears in Figure 3.



**Figure 2: Magellan Functional Block Diagram**

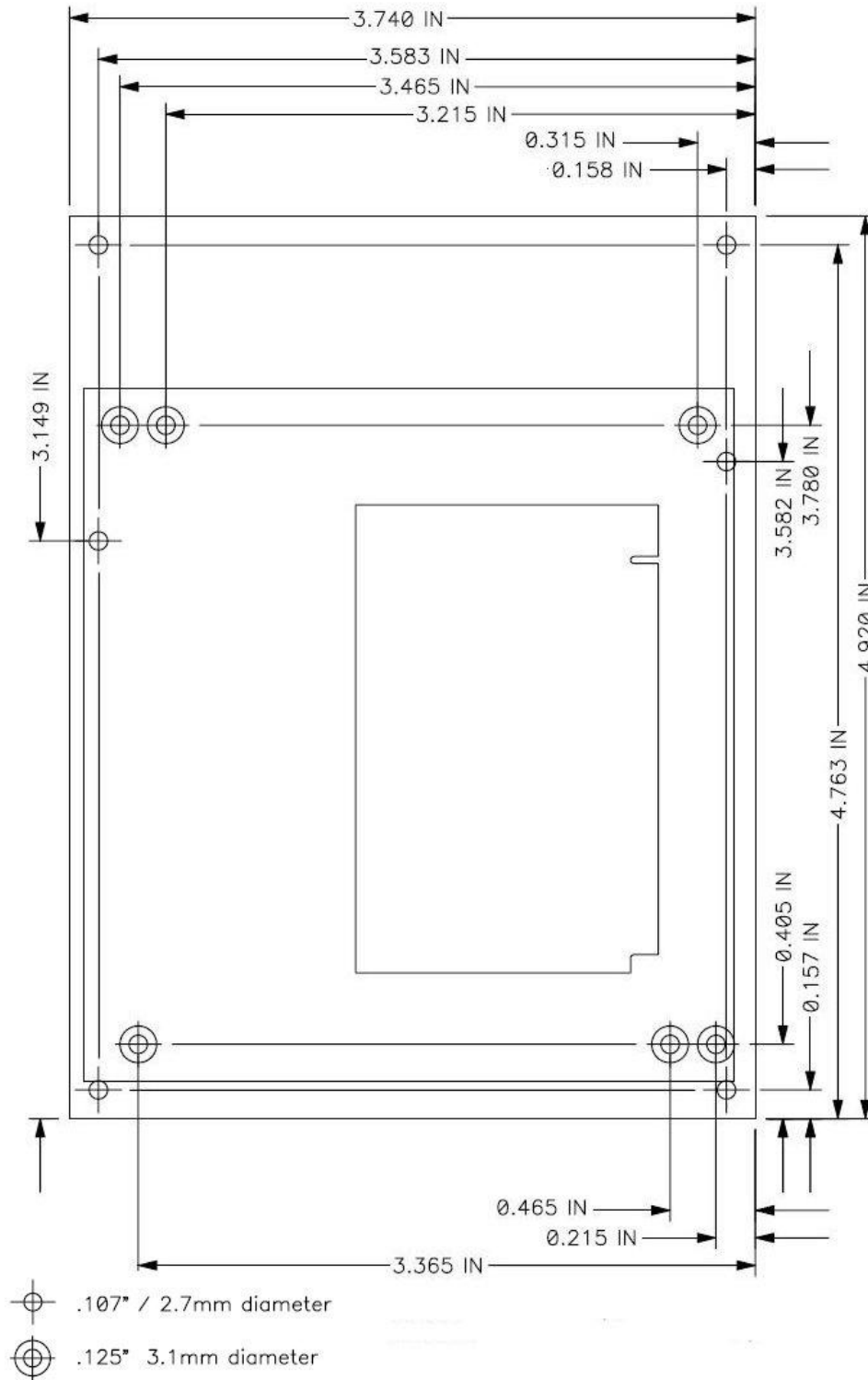




**Figure 3: Typical COM Express CPU Module Functional Block Diagram**

## 2.2 Magellan Baseboard Dimensions

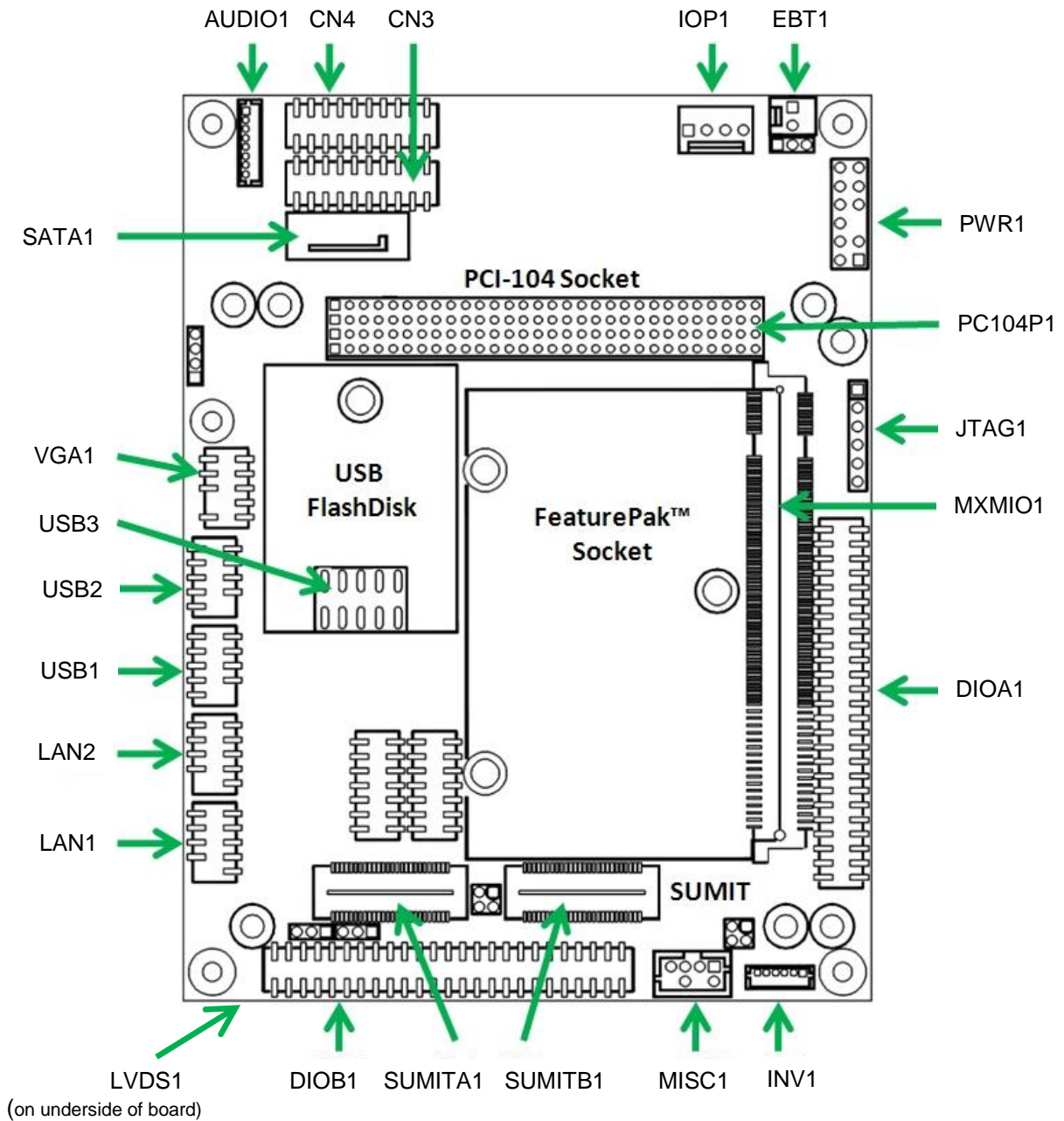
Figure 4 shows the overall dimensions of the Magellan baseboard.



**Figure 4: Baseboard Dimensions**

### 2.3 Baseboard Connector Locations

The diagram in Figure 5 illustrates the position of interface and bus connectors jumpers located on the Magellan baseboard. Magellan's COM Express CPU module plugs into two high-density connectors on the baseboard's bottom side, and is secured via screws and standoffs to the baseboard's four corner mounting holes.



**Figure 5: Magellan Baseboard Connector Locations**

### 2.3.1 Connector Summary

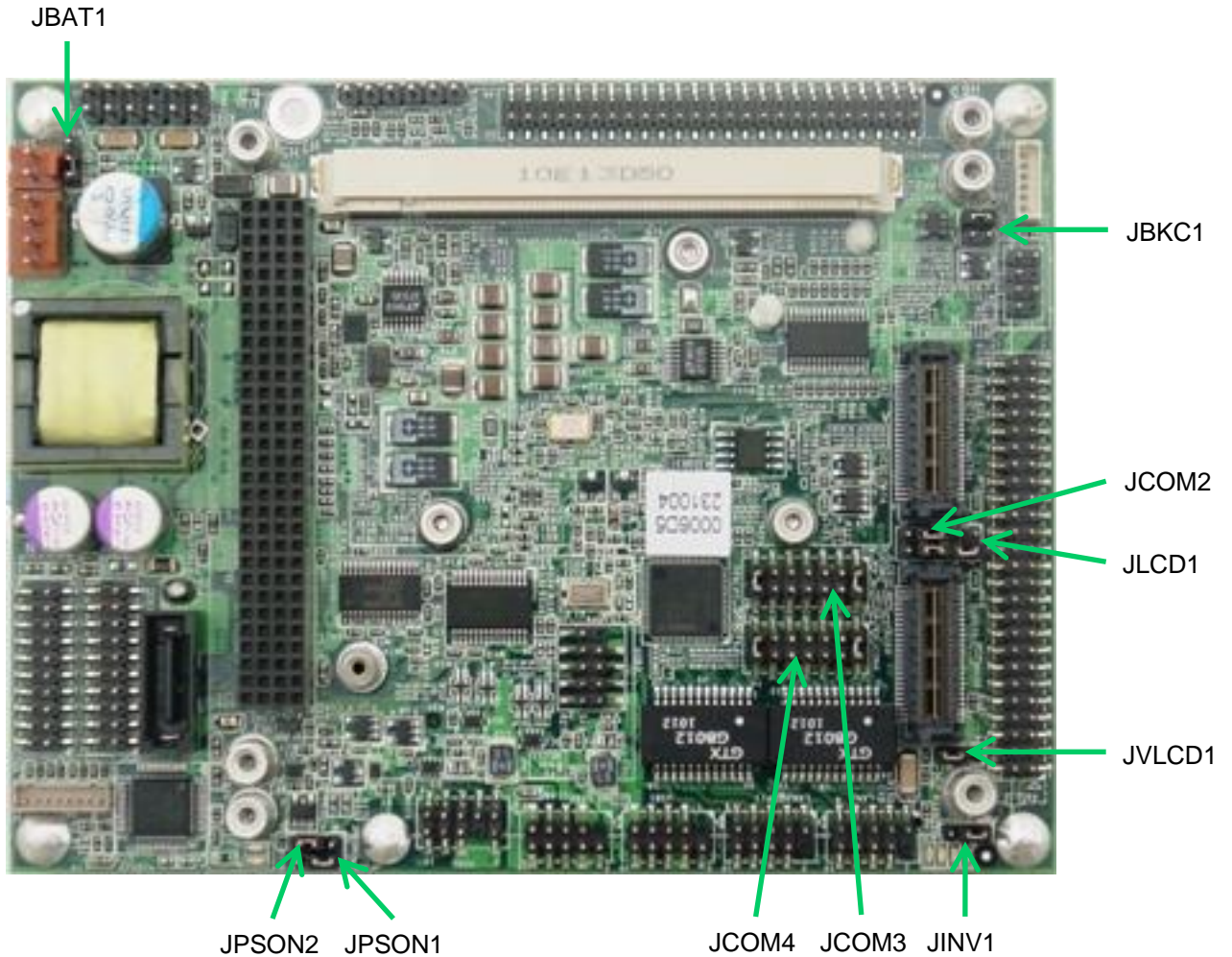
The following table summarizes the functions of Magellan's interface, utility, and power connectors. Signal functions relating to all of Magellan's interface connectors are discussed in greater detail in Section 4 of this document.

*Note: Diamond offers an optional Magellan Cable Kit (C-MAG-KIT), which provides mating cable assemblies for most of Magellan's I/O interface connectors.*

| <b>Connector Function</b>  | <b>Silkscreen Label</b> | <b>Connector Type</b>   |
|----------------------------|-------------------------|---|
| Audio output               | AUDIO1                  | 8-pin shrouded header   |
| Serial Ports               | CN3, CN4                | 20-pin dual-row header  |
| Auxiliary power output     | IOP1                    | 4-pin single-row plug   |
| External battery input     | EBT1                    | 2-pin plug  |
| Input power                | PWR1                    | 12-pin dual-row header  |
| PCI-104 expansion bus      | PC104P1                 | 120-pin quad-row socket                                       |
| JTAG interface             | JTAG1                   | 6-pin single-row header                                       |
| FeaturePak socket          | MXMIO1                  | 230-pin MXM socket  |
| I/O Connector A            | DIOA1                   | 50-pin dual-row header  |
| LCD backlight              | INV1                    | 6-pin shrouded header   |
| Auxiliary signals          | MISC1                   | 8-pin dual-row socket   |
| SUMIT bus                  | SUMITA1,                | 52-pin female sockets   |
| I/O Connector B            | DIOB1                   | 50-pin dual-row header  |
| Gigabit Ethernet           | LAN1, LAN2              | 10-pin dual-row header  |
| USB ports 0-3              | USB1, USB2              | 10-pin dual-row header  |
| USB flash module socket    | USB3                    | 10-pin dual-row header  |
| VGA                        | VGA1                    | 10-pin dual-row header  |
| SATA                       | SATA1                   | Standard SATA interface connector                             |
| LCD panel interface (LVDS) | JLVDS1                  | 20-pin single-row socket<br>(on Magellan baseboard underside) |

## 2.4 Baseboard Configuration Jumpers

Figure 6 shows the configuration jumper groups that are located on the topside of the Magellan baseboard. Refer to Section 5 of this document for details on the functions and configuration options associated with each jumper group.



**Figure 6: Magellan Baseboard Configuration Jumper Groups**



### 2.4.1 Configuration Jumper Summary

The Magellan baseboard's configuration jumpers are listed below. Refer to Section 5 of this document for details regarding the configuration of these jumper groups.

| <b>Jumper Group Function</b>                    | <b>Silkscreen Label</b> | <b>Array Size</b> |
|---|-------------------------|-------------------|
| External CMOS/RTC backup battery enable         | JBAT1                   | 1 x 3             |
| LCD backlight mode select                       | JBKC1                   | 2 x 2             |
| LCD panel signal control                        | JLCD1                   | 2 x 2             |
| LCD panel power select (3.3V/5V)                | JVLCD1                  | 1 x 3             |
| LCD backlight inverter power select (5V/12V)    | JINV1                   | 1 x 3             |
| Serial port COM4 mode select                    | JCOM4                   | 2 x 7             |
| Serial port COM3 mode select                    | JCOM3                   | 2 x 7             |
| Serial port signals to MXM or Supper I/O (COM2) | JCOM2                   | 2 x 3             |
| On-board power supply power-up/down behavior    | JPSON1                  | 1 x 3             |
| On-board power supply power-up/down behavior    | JPSON2                  | 1 x 3             |

## 3. GETTING STARTED

First-time Magellan users normally receive the product as part of Diamond's Magellan Development Kit, which provides everything needed to ensure rapid application development. This section of the Magellan User Manual covers basic hardware setup, power connection, system boot-up, and initial software configuration. After Magellan is up and running, refer to the later sections of this manual for the detailed hardware and software reference information needed to adapt the product to specific applications.

#### Important Safe-Handling Information



**WARNING: ESD-Sensitive Electronic Equipment!**

Observe ESD-safe handling procedures when working with this product.

Always use this product in a properly grounded work area and wear appropriate ESD-preventive clothing and/or accessories.

Always store this product in ESD-protective packaging when not in use.

Please refer to page 4 of this manual ("Important Safe-Handling Information") for further details.

### 3.1 Introducing the Magellan Development Kit

The Magellan Development Kit provides everything required for Magellan-based rapid application development. The table below lists the boards, cables, and other items included. Item 1 depends on the Magellan Development Kit model ordered.

| <i>Item</i> | <i>Diamond P/N</i> | <i>Description</i>                                   |
|-------------|--------------------|--|
| 1           | MAG-965LC-1GF      | 1.6GHz Core 2 Duo LV CPU, 1GB RAM, fansink <b>OR</b> |
|             | MAG-Z510-1G        | 1.1GHz Atom CPU, 1GB RAM, heatspreader               |
| 2           | C-MAG-KIT          | Magellan Cable Kit                                   |
| 3           | 8890400            | 4GB USB flashdisk with Linux 2.6 pre-loaded          |
| 4           | PS-12V-01          | 12V AC Power Adapter                                 |
| 5           | 6981036            | PS-12V-01 to Magellan Cable                          |
| 6           | 7460031            | Magellan Quick Start Guide                           |
| 7           | DOC-PKG            | Documentation Package                                |

### 3.1.1 Magellan Cable Kit

The Magellan Cable Kit (C-MAG-KIT) provides convenient access to most of Magellan’s I/O features. The kit’s cable assemblies are shown in the photo below, and identified in the table that follows.



**Note:** On each interface cable, the end of the cable connector that has a red wire going to it should be oriented toward the end of the board connector that is labeled “pin 1” (typically the pin with a square bad on the PCB).

| <b>Item</b> | <b>Qty</b> | <b>Diamond P/N</b> | <b>Description</b>                      | <b>Connects to...</b> |
|-------------|------------|--------------------|---|-----------------------|
| 1           | 2          | 6981080            | Ethernet                                | LAN1, LAN2            |
| 2           | 2          | 6981082            | USB                                     | USB1, USB2            |
| 3           | 1          | 6981006            | Power Out                               | IOP1                  |
| 4           | 1          | 6981084            | VGA                                     | VGA1                  |
| 5           | 2          | 6981081            | Serial                                  | CN3, CN4              |
| 6           | 1          | 6981088            | Utility                                 | MISC1                 |
| 7           | 1          | 6981401            | Power In                                | PWR1                  |
| 8           | 1          | 6981402            | Audio                                   | AUDIO1                |
| 9           | 1          | 6981036            | PS-12V-01 to Magellan power input cable | PWR1                  |

## 3.2 System Setup

This section outlines a simple process for preparing the Magellan single board computer for first-time operation. Additional details regarding Magellan's interface functions and connections may be found in Section 4 of this document ("Interface Connector Details") and from the appropriate COM Express CPU module's user manual.

### 3.2.1 Display

Magellan provides interfaces for both VGA monitors and LVDS flat panel displays. Recognizing the complexities associated with connection to parallel-interfaced flat panels, this quick-start process assumes you are using a standard VGA-compatible LCD or CRT monitor. Connect the VGA interface cable, 6981084, between connector VGA1 and a VGA-compatible display.

### 3.2.2 Keyboard and Mouse

Magellan supports operation using USB-based keyboard and mouse devices. Plug a USB interface cable, 6981082, from the Magellan Cable Kit into the designated connector (USB1 or USB2) on the baseboard. Then plug the keyboard and mouse interface cables into the mating connectors on the Magellan interface cables.

### 3.2.3 USB Flashdisk Socket

Magellan provides a location for on-board installation of an optional USB flashdisk on connector USB3. A mounting hole and stand-off location are provided for securing the module to the board. Install the USB flashdisk, 8890400, included in the Development Kit on connector USB3 and secure with the screw and standoff.

### 3.2.4 Mass Storage Devices

Depending on the specific COM Express CPU module integrated into your Magellan ERS, Magellan can operate with a combination of SATA and CD-ROM drives, and can boot from either of them. Connect the required drive(s) to Magellan's SATA1, and/or USB1 or USB2 connectors.

**Caution!** Be sure the system power supply is disconnected from its AC power source prior to performing the following step.

### 3.2.5 Connecting Power

Connect Magellan and its disk drives to an external source of power, as follows:

- Connect the PS-12V-01 power adapter to the 6981036 cable provided. Connect the other end of the 6981036 cable to the input power connector on Magellan, PWR1.
- Connect additional power cable(s) between the SATA and/or CD-ROM drives and an appropriate external DC power source (typically +5V). Alternatively, connector J4 (labeled "IOP1") on the Magellan baseboard provides a convenient source of +5V and +12V DC power for operation of a single external disk drive.

### 3.2.6 Installing Magellan in an Enclosure (optional)

Magellan mounts to an enclosure via a standardized 4-hole, 2.8" center mounting pattern on the heatspreader attached to the bottom of its COM Express CPU module.

Attach Magellan to an enclosure using four #6-32 screws via these holes. Select four #6-32 threaded screws of the proper length and head type to work with your enclosure. Allow a minimum of 0.25" and maximum of 0.40" screw length for insertion into Magellan's heatspreader. The total screw length will depend on the thickness of your enclosure wall.

Depending on your cooling requirements, it may be necessary to install a thermal gasket – or apply heat conductive compound – between the heatspreader and the enclosure. See section 1.4 for additional thermal considerations.

### 3.3 Booting the System

Power-up the VGA video monitor and any external disk drives or CD-ROM drives. Then connect the ac plug on the PS-12V-01 into an appropriate AC outlet. Magellan should begin its boot-up sequence immediately, as evidenced by BIOS messages on the connected VGA display. You can run the BIOS Setup utility and proceed to install an operating system on the boot drive just as you would on a normal desktop PC.

**Note:** *This process may vary according to the specific COM Express CPU module attached to the Magellan's baseboard's bottom side. Refer to the particular COM Express module's user manual for particulars.*

#### 3.3.1 BIOS Setup

The Magellan COM Express CPU module's BIOS ROM provides a wide range of configuration options. When you power up Magellan for the first time, you should immediately enter the BIOS "Setup" utility in order to adjust BIOS settings to match your system's peripheral devices and other requirements and to configure various other hardware and software parameters.

Options configurable via Setup typically include:

- Number and type of mass storage devices
- Boot device priority
- Video display type and resolution
- SATA, serial, and parallel interface modes and protocols
- PCI and PnP configuration
- Power management setup
- Automatic power-up after LAN connection, RTC alarm, power resumption, etc.
- System monitoring and security functions

The precise configuration options available via the BIOS Setup utility – and the specific keystroke sequence required to launch Setup on power-up – vary according to the specific COM Express CPU module attached to the Magellan Baseboard. Refer to the COM Express CPU module's user manual for further details.

#### 3.3.2 Operating System Drivers

Magellan will boot and run a Linux 2.6 operating system from the USB flashdisk. Magellan is now fully operational.

If you desire to run a different operating system, depending on the operating system to be installed on your Magellan SBC, it may be necessary to install software drivers for on-board interface controllers. The driver requirements (if any) will depend on both the Magellan baseboard and the attached COM Express CPU module. Drivers for Windows XP, XPe, and Linux 2.6, if required, are included on the Software and Documentation CD that is included in the Magellan Development Kit. This software is also available for download from the Magellan webpage at Diamond's website, [www.diamondsystems.com/products/magellan](http://www.diamondsystems.com/products/magellan).



## 4. INTERFACE CONNECTOR DETAILS


This section describes the functions associated with the Magellan baseboard's FeaturePak socket, SUMIT bus connector pair, PCI-104 bus expansion stack, utility, I/O interface, and power connectors in greater detail. Section 3.1.1 contains a list of ready-to-use interface cables included in Diamond's Magellan Cable Kit.

Many of the signals present on Magellan's interface connectors are derived directly from signals on the attached COM Express CPU module's high density COM Express bus connectors. Please refer to the particular COM Express module's user manual for further details on the definition and utilization of these signals. Additional information on these signals appears in the COM Express Design Guide, which is available from the PICMG website at <http://www.picmg.org/v2internal/COMExpress.htm>.

### 4.1 Audio Output (AUDIO1)

Connector AUDIO1 (refer to Figure 5 on page 11 for location) provides the board's AC'97 stereo audio inputs/outputs, as indicated below.

|   |         |
|---|---------|
| 1 | LOUT_L  |
| 2 | AGND    |
| 3 | LOUT_R  |
| 4 | LIN_L   |
| 5 | AGND    |
| 6 | LIN_R   |
| 7 | MIC_PWR |
| 8 | MIC     |



**Connector type:** Molex 53047-0810 or equivalent

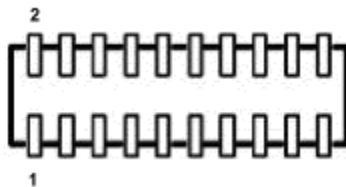
**Mating Cable Connector socket:** Molex 51021-0800 or equivalent

**Terminals:** Molex 50058 / 50079 series or equivalent

### 4.2 Serial Ports (CN3, CN4)

These two 20-pin connectors provide access to the board's four serial ports, labeled CN3 and CN4 on the PCB. Serial ports COM1 and COM2 (on connector CN3) are fixed at RS-232 only, while serial COM3 and COM4 (on connector CN4) may be jumper-configured for RS-232, RS-422, or RS-485 protocols.

The signals present on the pins of connector CN4 depend on the selected protocol, as indicated in the three sets of pinouts pictured below. The RS-232 configuration signal assignments pertain to both CN3 and CN4, while the RS-422 and RS-485 signal assignments pertain to CN4 only.



Refer to the tables on the next page for details on the configuration of these two connectors based on their mode of use.

**RS-232 Configuration (CN3 and CN4):**

| Connector CN3 |       |    |    | Connector CN4 |       |    |    |       |             |
|---------------|-------|----|----|---------------|-------|----|----|-------|-------------|
| <b>COM1</b>   | DCD 1 | 1  | 2  | DSR 1         | DCD 3 | 1  | 2  | DSR 3 | <b>COM3</b> |
|               | RXD 1 | 3  | 4  | RTS 1         | RXD 3 | 3  | 4  | RTS 3 |             |
|               | TXD 1 | 5  | 6  | CTS 1         | TXD 3 | 5  | 6  | CTS 3 |             |
|               | DTR 1 | 7  | 8  | RI 1          | DTR 3 | 7  | 8  | RI 3  |             |
|               | GND   | 9  | 10 | NC            | GND   | 9  | 10 | NC    |             |
| <b>COM2</b>   | DCD 2 | 11 | 12 | DSR 2         | DCD 4 | 11 | 12 | DSR 4 | <b>COM4</b> |
|               | RXD 2 | 13 | 14 | RTS 2         | RXD 4 | 13 | 14 | RTS 4 |             |
|               | TXD 2 | 15 | 16 | CTS 2         | TXD 4 | 15 | 16 | CTS 4 |             |
|               | DTR 2 | 17 | 18 | RI 2          | DTR 4 | 17 | 18 | RI 4  |             |
|               | GND   | 19 | 20 | NC            | GND   | 19 | 20 | NC    |             |

**RS-422 Configuration (CN4 only):**

| Connector CN4 |        |    |    |        |
|---------------|--------|----|----|--------|
| <b>COM3</b>   | NC     | 1  | 2  | RXD-3  |
|               | RXD+ 3 | 3  | 4  | TXD- 3 |
|               | TXD+3  | 5  | 6  | NC     |
|               | NC     | 7  | 8  | NC     |
|               | GND    | 9  | 10 | NC     |
| <b>COM4</b>   | NC     | 11 | 12 | RXD-4  |
|               | RXD+ 4 | 13 | 14 | TXD- 4 |
|               | TXD+4  | 15 | 16 | NC     |
|               | NC     | 17 | 18 | NC     |
|               | GND    | 19 | 20 | NC     |

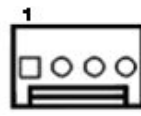
**RS-485 Configuration (CN4 only):**

| Connector CN4 |           |    |    |            |
|---------------|-----------|----|----|------------|
| <b>COM3</b>   | NC        | 1  | 2  | NC         |
|               | NC        | 3  | 4  | TXD/RXD- 3 |
|               | TXD/RXD+3 | 5  | 6  | NC         |
|               | NC        | 7  | 8  | NC         |
|               | GND       | 9  | 10 | NC         |
| <b>COM4</b>   | NC        | 11 | 12 | NC         |
|               | NC        | 13 | 14 | TXD/RXD- 4 |
|               | TXD/RXD+4 | 15 | 16 | NC         |
|               | NC        | 17 | 18 | NC         |
|               | GND       | 19 | 20 | NC         |

**Connector type:** Standard 2mm dual row straight pin header with 4mm posts and gold flash plating

### 4.3 Auxiliary Power Output (IOP1)

Connector IOP1 on the PCB may be used to provide power to an external drive or other external peripheral. This connector is for OUTPUT ONLY and must not be driven by an external power source. The typical +12V output current of the Magellan baseboard is 4A, which includes the +12V power for the COM module. So if the attached COM module draws 1.5A, then 2.5A is available on the +12V pin on IOP1. The typical +5V output current is 3A.

|   |          |  |
|---|----------|--|
| 1 | +5V Out  |  |
| 2 | Ground   |  |
| 3 | Ground   |  |
| 4 | +12V Out |  |

**Connector type:** HR, A2542WVA-04P vertical pin header

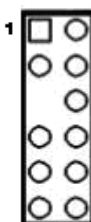
### 4.4 External Battery Input (EBT1)

Connector labeled EBT1 is used for optional connection of an external battery for backup of the board's CMOS RAM SETUP data and continued operation the real-time clock in the absence of system power. Use of the external battery option requires an appropriate jumper setting in jumper group JBAT1 as described in Section 5.

### 4.5 Input Power (PWR1)

Connector labeled PWR1 on the PCB can supply power to Magellan from two alternative sources: +Vin-A or +Vin-B. +Vin-A is the primary power source, while +Vin-B is an alternate source such as a redundant fail-over supply, solar-powered supply, or battery backup supply.

SW- is a switch signal pulled up in Magellan's on-board power supply subsystem and on the COM Express module. An optional external two-pin momentary pushbutton switch can be connected between this pin and ground, for ATX-style power control including ACPI power-saving operation. A jumper group (JPSON1 & JPSON2) governs the power up/down behavior of the board (see Section 5).

|        |    |    |        |  |
|--------|----|----|--------|--|
| Ground | 1  | 2  | +Vin-A |  |
| Ground | 3  | 4  | +Vin-A |  |
| Key    | 5  | 6  | +Vin-A |  |
| Ground | 7  | 8  | +Vin-B |  |
| Ground | 9  | 10 | +Vin-B |  |
| SW-    | 11 | 12 | +Vin-B |  |

**Connector type:** Standard 0.1-inch pitch single row straight pin header with gold flash plating

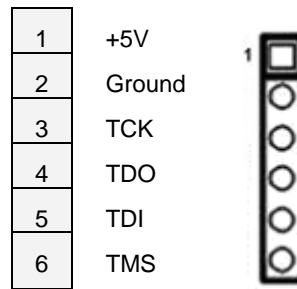
## 4.6 PCI-104 (PCI) Expansion Bus (PC104P1)

The PCI-104 stackable bus, connector PC104P1, consists of a 120-pin female pin header connector with the pin assignment shown below. This bus implements a ruggedized version of the industry standard PCI expansion bus. For more information on the PC/104-*Plus* specification, visit the PC/104 Embedded Consortium website, at <http://www.pc104.org>.

|          |     |     |       |        |     |     |              |
|----------|-----|-----|-------|--------|-----|-----|--------------|
| GND/5.0V | A1  | B1  | RSVD  | +5V    | C1  | D1  | AD00         |
| VI/O     | A2  | B2  | AD02  | AD01   | C2  | D2  | +5V          |
| AD05     | A3  | B3  | GND   | AD04   | C3  | D3  | AD03         |
| CMD/BE0- | A4  | B4  | AD07  | GND    | C4  | D4  | AD06         |
| GND      | A5  | B5  | AD09  | AD08   | C5  | D5  | GND          |
| AD11     | A6  | B6  | VI/O  | AD10   | C6  | D6  | M66EN        |
| AD14     | A7  | B7  | AD13  | GND    | C7  | D7  | AD12         |
| +3.3V    | A8  | B8  | CMD/B | AD15   | C8  | D8  | +3.3V        |
| SERR-    | A9  | B9  | GND   | SB0-   | C9  | D9  | PAR          |
| GND      | A10 | B10 | PERR- | +3.3V  | C10 | D10 | SDONE        |
| STOP-    | A11 | B11 | +3.3V | LOCK-  | C11 | D11 | GND          |
| +3.3V    | A12 | B12 | TRDY- | GND    | C12 | D12 | DEVSEL-      |
| FRAME-   | A13 | B13 | GND   | IRDY-  | C13 | D13 | +3.3V        |
| GND      | A14 | B14 | AD16  | +3.3V  | C14 | D14 | CMD/BE2-     |
| AD18     | A15 | B15 | +3.3V | AD17   | C15 | D15 | GND          |
| AD21     | A16 | B16 | AD20  | GND    | C16 | D16 | AD19         |
| +3.3V    | A17 | B17 | AD23  | AD22   | C17 | D17 | +3.3V        |
| IDSEL0   | A18 | B18 | GND   | IDSEL1 | C18 | D18 | IDSEL2       |
| AD24     | A19 | B19 | CMD/B | VI/O   | C19 | D19 | IDSEL3       |
| GND      | A20 | B20 | AD26  | AD25   | C20 | D20 | GND          |
| AD29     | A21 | B21 | +5V   | AD28   | C21 | D21 | AD27         |
| +5V      | A22 | B22 | AD30  | GND    | C22 | D22 | AD31         |
| REQ0-    | A23 | B23 | GND   | REQ1-  | C23 | D23 | VI/O         |
| GND      | A24 | B24 | REQ2- | +5V    | C24 | D24 | GNT0-        |
| GNT1-    | A25 | B25 | VI/O  | GNT2-  | C25 | D25 | GND          |
| +5V      | A26 | B26 | CLK0  | GND    | C26 | D26 | CLK1         |
| CLK2     | A27 | B27 | +5V   | CLK3   | C27 | D27 | GND          |
| GND      | A28 | B28 | INTD- | +5V    | C28 | D28 | RST-         |
| +12V     | A29 | B29 | INTA- | INTB-  | C29 | D29 | INTC-        |
| -12V     | A30 | B30 | RSVD  | RSVD   | C30 | D30 | GND/3.3V Key |

## 4.7 JTAG Interface (JTAG1)

Connector labeled JTAG1 on the PCB can be used for programming certain FeaturePak modules' internal logic, such as an FPGA, at the factory or by a user. The JTAG interface cannot be used to communicate with the CPU.



**Connector type:** Standard .1" single row straight pin header with gold flash plating

## 4.8 FeaturePak Expansion Socket (MXMIO1)

The FeaturePak socket connector, labeled MXMIO1 on the PCB, is an MXM-style socket with 230 pins in two rows as shown below. The Magellan baseboard implements the following FeaturePak socket interface functions:

- One PCI Express x1 lane
- Two USB 2.0 ports
- JTAG
- SMBus
- PCI

The standard signal assignments of the FeaturePak socket appear on the following page.

**Note:** For FeaturePak socket pin numbering and other FeaturePak specification details, visit the FeaturePak Trade Association website at <http://www.featurepak.org>.



### FeaturePak Socket Signal Assignment

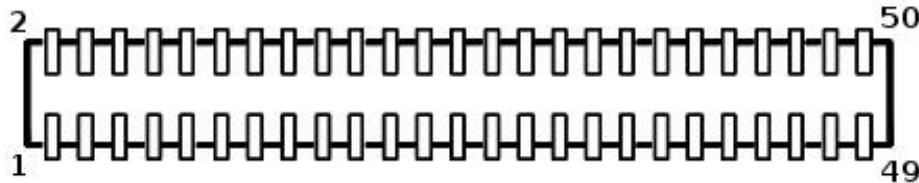
| Pins 1 – 114 |     |     | Pin 115 – 230 |         |         |         |
|--------------|-----|-----|---------------|---------|---------|---------|
| +3.3V        | 1   | 2   | +12V          | I/OB-26 | 115 116 | I/OB-25 |
| +3.3V        | 3   | 4   | PS-Current    | I/OB-24 | 117 118 | I/OB-23 |
| Ground       | 5   | 6   | Ground        | I/OB-22 | 119 120 | I/OB-21 |
| PCle-TX1+    | 7   | 8   | PCle-RX1+     | I/OB-20 | 121 122 | I/OB-19 |
| PCle-TX1-    | 9   | 10  | PCle-RX1-     | I/OB-18 | 123 124 | I/OB-17 |
| Ground       | 11  | 12  | Ground        | I/OB-16 | 125 126 | I/OB-15 |
| PCle-CLK1+   | 13  | 14  | PCle-CLK2+    | I/OB-14 | 127 128 | I/OB-13 |
| PCle-CLK1-   | 15  | 16  | PCle-CLK2-    | I/OB-12 | 129 130 | I/OB-11 |
| Ground       | 17  | 18  | Ground        | I/OB-10 | 131 132 | I/OB-9  |
| PCle-TX2+    | 19  | 20  | PCle-RX2+     | I/OB-8  | 133 134 | I/OB-7  |
| PCle-TX2-    | 21  | 22  | PCle-RX2-     | I/OB-6  | 135 136 | I/OB-5  |
| Ground       | 23  | 24  | Ground        | I/OB-4  | 137 138 | I/OB-3  |
| PCle-Reset-  | 25  | 26  | Reserved      | I/OB-2  | 139 140 | I/OB-1  |
| Reserved     | 27  | 28  | Reserved      | +5V     | 141 142 | Ground  |
| Reserved     | 29  | 30  | Reserved      | +5V     | 143 144 | Ground  |
| Reserved     | 31  | 32  | Reserved      | +5V     | 145 146 | Ground  |
| Reserved     | 33  | 34  | Reserved      | I/OA-50 | 147 148 | I/OA-49 |
| Ground       | 35  | 36  | Ground        | I/OA-48 | 149 150 | I/OA-47 |
| USB-Ch1+     | 37  | 38  | USB-Ch2+      | I/OA-46 | 151 152 | I/OA-45 |
| USB-Ch1-     | 39  | 40  | USB-Ch2-      | I/OA-44 | 153 154 | I/OA-43 |
| Ground       | 41  | 42  | Ground        | I/OA-42 | 155 156 | I/OA-41 |
| +3.3V        | 43  | 44  | USB-OC1/2-    | I/OA-40 | 157 158 | I/OA-39 |
| +3.3V        | 45  | 46  | Serial-RX1    | I/OA-38 | 159 160 | I/OA-37 |
| Serial-TX1   | 47  | 48  | Serial-CTS1   | I/OA-36 | 161 162 | I/OA-35 |
| Serial-RTS1  | 49  | 50  | SMBclk        | (NC)    | 163 164 | (NC)    |
| SMBAlert#    | 51  | 52  | SMBdata       | I/OA-34 | 165 166 | I/OA-33 |
| Slot ID 2    | 53  | 54  | Slot ID 1     | (NC)    | 167 168 | (NC)    |
| Slot ID 0    | 55  | 56  | Present-      | I/OA-32 | 169 170 | I/OA-31 |
| JTAG-TDI     | 57  | 58  | JTAG-TDO      | (NC)    | 171 172 | (NC)    |
| JTAG-CLK     | 59  | 60  | JTAG-TMS      | I/OA-30 | 173 174 | I/OA-29 |
| Sys-Reset-   | 61  | 62  | Reserved      | (NC)    | 175 176 | (NC)    |
| +3.3V        | 63  | 64  | Ground        | I/OA-28 | 177 178 | I/OA-27 |
| +3.3V        | 65  | 66  | Ground        | (NC)    | 179 180 | (NC)    |
| Reserved     | 67  | 68  | Reserved      | I/OA-26 | 181 182 | I/OA-25 |
| Reserved     | 69  | 70  | Reserved      | (NC)    | 183 184 | (NC)    |
| +3.3V        | 71  | 72  | Ground        | I/OA-24 | 185 186 | I/OA-23 |
| Reserved     | 73  | 74  | Reserved      | (NC)    | 187 188 | (NC)    |
| Reserved     | 75  | 76  | Reserved      | I/OA-22 | 189 190 | I/OA-21 |
| +3.3V        | 77  | 78  | Ground        | (NC)    | 191 192 | (NC)    |
| Reserved     | 79  | 80  | Reserved      | I/OA-20 | 193 194 | I/OA-19 |
| Reserved     | 81  | 82  | Reserved      | (NC)    | 195 196 | (NC)    |
| Reserved     | 83  | 84  | Reserved      | I/OA-18 | 197 198 | I/OA-17 |
| Reserved     | 85  | 86  | Reserved      | (NC)    | 199 200 | (NC)    |
| +5V          | 87  | 88  | Ground        | I/OA-16 | 201 202 | I/OA-15 |
| +5V          | 89  | 90  | Ground        | (NC)    | 203 204 | (NC)    |
| I/OB-50      | 91  | 92  | I/OB-49       | I/OA-14 | 205 206 | I/OA-13 |
| I/OB-48      | 93  | 94  | I/OB-47       | (NC)    | 207 208 | (NC)    |
| I/OB-46      | 95  | 96  | I/OB-45       | I/OA-12 | 209 210 | I/OA-11 |
| I/OB-44      | 97  | 98  | I/OB-43       | (NC)    | 211 212 | (NC)    |
| I/OB-42      | 99  | 100 | I/OB-41       | I/OA-10 | 213 214 | I/OA-9  |
| I/OB-40      | 101 | 102 | I/OB-39       | (NC)    | 215 216 | (NC)    |
| I/OB-38      | 103 | 104 | I/OB-37       | I/OA-8  | 217 218 | I/OA-7  |
| I/OB-36      | 105 | 106 | I/OB-35       | (NC)    | 219 220 | (NC)    |
| I/OB-34      | 107 | 108 | I/OB-33       | I/OA-6  | 221 222 | I/OA-5  |
| I/OB-32      | 109 | 110 | I/OB-31       | (NC)    | 223 224 | (NC)    |
| I/OB-30      | 111 | 112 | I/OB-29       | I/OA-4  | 225 226 | I/OA-3  |
| I/OB-28      | 113 | 114 | I/OB-27       | (NC)    | 227 228 | (NC)    |
|              |     |     |               | I/OA-2  | 229 230 | I/OA-1  |

**Connector type:** Standard 2mm dual row straight pin headers with 4mm high posts and gold flash plating

## 4.9 I/O Connectors A and B (DIOA1, DIOB1)

These two 50-pin header connectors provide access to up to 100 I/O signals from an optional module located in the on-board FeaturePak expansion socket.

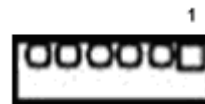
Pins 1-50 of each connector are bused directly to pins I/OA-1 through I/OA-50 or I/OB-1 through I/OB-50, respectively, on the FeaturePak socket. Connector DIOA1 is associated with FeaturePak I/O group A, and DIOB1 is associated with FeaturePak I/O group B.



## 4.10 LCD Backlight (INV1)

The 6-pin single-row header connector labeled INV1 on the PCB provides the backlight power and control for the optional LCD panel.

|   |                             |
|---|-----------------------------|
| 1 | +5V/+12V, jumper selectable |
| 2 | Power (same as pin 1)       |
| 3 | Ground                      |
| 4 | Ground                      |
| 5 | Backlight power enable      |
| 6 | Brightness                  |



**Connector type:** Molex 53047-0610 or equivalent

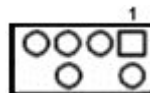
**Mating Cable Connector:** Socket: Molex 51021-0600 or equivalent

**Terminals:** Molex 50058 / 50079 series or equivalent

## 4.11 Auxiliary Signals Connector (MISC1)

Connector labeled MISC1 on the PCB provides several utility signals, as indicated in the figure below.

|   |                      |
|---|----------------------|
| 1 | LAN Link / Activity  |
| 2 | Ext. Power LED input |
| 3 | Ext. Battery Input   |
| 4 | (Key)                |
| 5 | Ground               |
| 6 | Ground               |
| 7 | Ext. Reset SW input  |
| 8 | (Key)                |

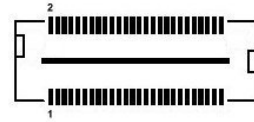


**Connector type:** Standard 2mm dual row straight pin header with 4mm posts and gold flash plating

## 4.12 SUMIT Expansion Bus (SUMITA1, SUMITB1)

The SUMIT stackable bus consists of two 52-pin connectors; SUMITA1 and SUMITB1. The Magellan baseboard implements the following SUMIT bus functions:

- Up to three PCI Express x1 lanes (depending on how many PCIe lanes are available from the attached COM Express CPU module)
- One USB 2.0 port
- Low Pin Count (LPC) bus
- SMBus



The standard signal assignments of the SUMIT A and B connectors appear in below. Note: for more information on the SUMIT specification, visit the SFF-SIG website at <http://www.sff-sig.org>.

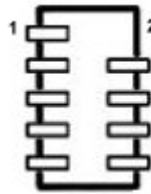
| SUMIT A Connector (SUMITA1) |    |    |                | SUMIT B Connector (SUMITB1) |    |    |             |
|-----------------------------|----|----|----------------|-----------------------------|----|----|-------------|
| +5VSB                       | 1  | 2  | +12V           | GND                         | 1  | 2  | GND         |
| 3.3V                        | 3  | 4  | SMB_DATA       | B_PETp0                     | 3  | 4  | B_PERp0     |
| 3.3V                        | 5  | 6  | SMB_CLK        | B_PETn0                     | 5  | 6  | B_PERn0     |
| EXPCD_REQ#                  | 7  | 8  | SMB_ALERT#     | GND                         | 7  | 8  | BPRSNT#/GND |
| EXPCD_PRSNT#                | 9  | 10 | SPI/uWire_DO   | C_CLKp                      | 9  | 10 | B_CLKp      |
| USB_OC#                     | 11 | 12 | SPI/uWire_DI   | C_CLKn                      | 11 | 12 | B_CLKn      |
| RSVD                        | 13 | 14 | SPI/uWire_CLK  | CPRSNT#/GND                 | 13 | 14 | GND         |
| +5V                         | 15 | 16 | SPI/uWire_CS0# | C_PETp0                     | 15 | 16 | C_PERp0     |
| USB3+                       | 17 | 18 | SPI/uWire_CS1# | C_PETn0                     | 17 | 18 | C_PERn0     |
| USB3-                       | 19 | 20 | RSVD           | GND                         | 19 | 20 | GND         |
| +5V                         | 21 | 22 | LPC_DRQ        | C_PETp1                     | 21 | 22 | C_PERp1     |
| USB2+                       | 23 | 24 | LPC_AD0        | C_PETn1                     | 23 | 24 | C_PERn1     |
| USB2-                       | 25 | 26 | LPC_AD1        | GND                         | 25 | 26 | GND         |
| +5V                         | 27 | 28 | LPC_AD2        | C_PETp2                     | 27 | 28 | C_PERp2     |
| USB1+                       | 29 | 30 | LPC_AD3        | C_PETn2                     | 29 | 30 | C_PERn2     |
| USB1-                       | 31 | 32 | LPC_FRAME#     | GND                         | 31 | 32 | GND         |
| +5V                         | 33 | 34 | SERIRQ#        | C_PETp3                     | 33 | 34 | C_PERp3     |
| USB0+                       | 35 | 36 | LPC_PRSNT#/GND | C_PETn3                     | 35 | 36 | C_PERn3     |
| USB0-                       | 37 | 38 | CLK_33MHz      | GND                         | 37 | 38 | GND         |
| GND                         | 39 | 40 | GND            | PERST#                      | 39 | 40 | WAKE#       |
| A_PETp0                     | 41 | 42 | A_PERp0        | RSVD                        | 41 | 42 | RSVD        |
| A_PETn0                     | 43 | 44 | A_PERn0        | +5V                         | 43 | 44 | RSVD        |
| GND                         | 45 | 46 | APRSNT#/GND    | +5V                         | 45 | 46 | 3.3V        |
| PERST#                      | 47 | 48 | A_CLKp         | +5V                         | 47 | 48 | 3.3V        |
| WAKE#                       | 49 | 50 | A_CLKn         | +5V                         | 49 | 50 | 3.3V        |
| +5V                         | 51 | 52 | GND            | +5V                         | 51 | 52 | +5VSB       |

These two surface-mounted 52-pin connectors are located on the expansion side of the board. Their mechanical requirements, pin-out, and signal functionality shall comply with the SFF-SIG's "SUMIT" and "SUMIT-ISM" specifications, available from the SFF-SIG (<http://sff-sig.org/sumit.html>).

### 4.13 Gigabit Ethernet (LAN1, LAN2)

The two 10-pin dual-row header connectors, labeled LAN1 and LAN2 on the PCB, provide access to the board's two gigabit Ethernet ports. One Ethernet port is provided by the attached COM Express module, while the second port is implemented by means of an Ethernet controller located on the Magellan baseboard.

|     |   |    |       |
|-----|---|----|-------|
| NC  | 1 | 2  | (Key) |
| DA+ | 3 | 4  | DA-   |
| DB+ | 5 | 6  | DB-   |
| DC+ | 7 | 8  | DC-   |
| DD+ | 9 | 10 | DD-   |

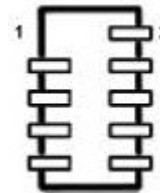


**Connector type:** Standard 2mm dual row straight pin header with 4mm posts and gold flash plating

### 4.14 USB Ports 0-3 (USB1, USB2)

These two 10-pin dual-row connectors, labeled USB1 and USB2 on the PCB, provide access to four of the board's eight USB 2.0 ports. Each of these connectors provides signals for a pair of USB ports, indicated by "USB port A" and "USB port B" in the pinout drawing below. The "Shield" pin is tied to system ground.

|                   |   |    |                   |
|-------------------|---|----|-------------------|
| (Key)             | 1 | 2  | Shield            |
| USB port B Power- | 3 | 4  | USB port A Power- |
| USB port B Data+  | 5 | 6  | USB port A Data+  |
| USB port B Data-  | 7 | 8  | USB port A Data-  |
| USB port B Power+ | 9 | 10 | USB port A Power+ |



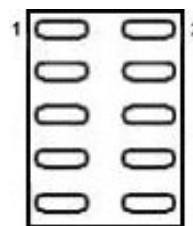
**Connector type:** Standard 2mm dual row straight pin header with 4mm posts and gold flash plating

### 4.15 USB Flash Module Socket (USB3)

Connector labeled USB3 on the PCB can accommodate an optional on-board USB flash memory module. The USB signals are NOT shared with any other device. Note: In order to support multiple USB module sources, there is no shield pin.

An accessory cable, C-FDU-01, is available that connects the USB flashdisk to any USB port. This simplifies programming the flashdisk, or downloading data from it, by providing a direct connection between the flashdisk and a host PC.

|            |   |    |    |
|------------|---|----|----|
| USB Pwr+   | 1 | 2  | NC |
| USB2 Data- | 3 | 4  | NC |
| USB2 Data+ | 5 | 6  | NC |
| USB Pwr-   | 7 | 8  | NC |
| NC         | 9 | 10 | NC |

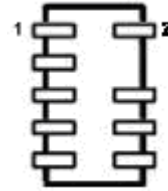


**Connector type:** Standard 0.1" dual row straight pin header with 4mm posts and gold flash plating

## 4.16 VGA (VGA1)

Connector labeled VGA1 on the PCB provides a standard RGB video connection for use with VGA-compatible LCD and CRT displays. Note that while the DDC serial detection pins are present, there is no +5V supply provided (nor are the old “Monitor ID” pins used).

|       |   |    |           |
|-------|---|----|-----------|
| RED   | 1 | 2  | Ground    |
| GREEN | 3 | 4  | (Key)     |
| BLUE  | 5 | 6  | Ground    |
| HSYNC | 7 | 8  | DDC-Data  |
| VSYNC | 9 | 10 | DDC-Clock |



**Connector type:** Standard 2mm dual row straight pin header with 4mm posts and gold flash plating

## 4.17 SATA (SATA1)

Magellan provides one industry-standard SATA connector, labeled SATA1 on the PCB. Although the attached COM Express CPU module may provide multiple SATA ports on its COM Express bus interface, only one SATA interface is supported on the Magellan baseboard.

|   |           |
|---|-----------|
| 1 | Ground    |
| 2 | Transmit+ |
| 3 | Transmit- |
| 4 | Ground    |
| 5 | Receive-  |
| 6 | Receive+  |
| 7 | Ground    |



**Connector type:** Industry-standard vertical SATA connector



## 4.18 LCD Panel Interface (LVDS1)

The 20-pin single-row connector labeled LVDS1 on the PCB – and located on the bottom side of Magellan – provides connection to an LVDS-interfaced LCD display. The LCD panel power is jumper-selectable for +3.3V (default) or +5V via jumper group JLCD1 (See Section 5).

|    |  |
|----|--|
| 1  | GND / D3+ depending on video chip                            |
| 2  | GND/D3-, depending on video chip                             |
| 3  | Scan Direction (High = Reverse scan, Low/open = Normal scan) |
| 4  | Frame Rate Control (High = On, Low/open = Off)               |
| 5  | Signal GND   |
| 6  | Pixel Clock +  |
| 7  | Pixel Clock -  |
| 8  | Signal GND   |
| 9  | D2+  |
| 10 | D2-  |
| 11 | Signal GND   |
| 12 | D1+  |
| 13 | D1-  |
| 14 | Signal GND   |
| 15 | D0+  |
| 16 | D0-  |
| 17 | Power GND  |
| 18 | Power GND  |
| 19 | Vcc 3.3V / 5V (jumper configured)                            |
| 20 | Vcc 3.3V / 5V (jumper configured)                            |

**Connector type:** JAE part no. FI-SE20P-HFE or equivalent

**Cable-mount socket:** JAE part no. FI-SE20S-2-L or equivalent

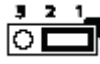
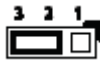
## 5. CONFIGURATION JUMPER DETAILS

This section explains the use of the jumper options on the Magellan Baseboard.

| <b>Jumper group function</b>                 | <b>Silkscreen label</b> | <b>Array size</b> |
|--|-------------------------|-------------------|
| External CMOS/RTC backup battery enable      | JBAT1                   | 1 x 3             |
| LCD backlight mode select                    | JBKC1                   | 2 x 2             |
| LCD panel signal control                     | JLCD1                   | 2 x 2             |
| LCD panel power select (3.3V/5V)             | JVLCD1                  | 1 x 3             |
| LCD backlight inverter power select (5V/12V) | JINV1                   | 1 x 3             |
| Serial port COM4 mode select                 | JRS2                    | 2 x 7             |
| Serial port COM3 mode select                 | JRS1                    | 2 x 7             |
| On-board power supply up/down behavior       | JPSON1                  | 1 x 3             |
| On-board power supply up/down behavior       | JPSON2                  | 1 x 3             |



### 5.1 External CMOS/RTC Backup Battery Enable (JBAT1)

Jumper group JBAT1 controls the external battery backup enable settings.

| <b>Setting</b> | <b>Mode</b>             |  |
|----------------|-------------------------|--|
| Short 1-2      | External battery enable |   |
| Short 2-3      | No battery (default)    |  |




### 5.2 LCD Backlight Brightness Control Selection (JBKC1)

Jumper group JBKC1 configures the mode of LCD brightness control. The brightness control is implemented by means of an analog voltage that can be provided to pin 6 of connector INV1 in two ways, as indicated below.

| <b>Setting</b> | <b>Mode</b>                                       |  |
|----------------|---|--|
| Short 1-2      | Directly from SBC backlight control pin (default) |  |
| Short 3-4      | Digital value from SBC converted by a D/A         |  |



### 5.3 LCD panel signal control (JLCD1)

Jumper group JLCD1 controls the LCD panel scan direction and frame rate control modes, as indicated below.

| <b>Setting</b> | <b>Mode</b>   |  |
|----------------|---|--|
| No jumpers     | Scan Direction :<br>REVERSE SCAN<br><br>Frame Rate Control :<br>ON<br><br>(default) |  |
| Short 1-3      | Frame Rate Control :<br>OFF   |  |
| Short 2-4      | Scan Direction :<br>NORMAL  |  |

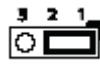
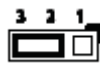
### 5.4 LCD panel power select (JVLCD1)

Jumper group JVLCD1 must be configured according to the type of LCD panel that will be attached to Magellan's LCD panel interface connector LVDS1, located on the bottom of the baseboard. The two alternative settings – for +5V or +3.3V DC powering of the LCD panel – are indicated below.

| <b>Setting</b> | <b>LCD Panel Voltage</b> |  |
|----------------|--------------------------|--|
| Short 1-2      | +5V                      |  |
| Short 2-3      | +3.3V (default)          |  |

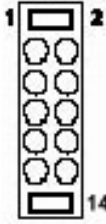
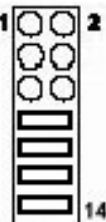
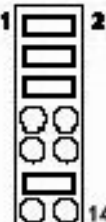
### 5.5 LCD backlight inverter power select (JINV1)

Jumper group JINV1 determines whether +5V or +12V DC power is supplied to pin 1 of connector INV1 for powering an external LCD backlight inverter.

| <b>Setting</b> | <b>LCD Backlight Power</b> |  |
|----------------|----------------------------|--|
| Short 1-2      | +5V                        |  |
| Short 2-3      | +12V (default)             |  |

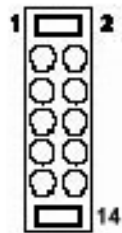
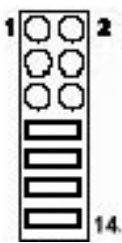
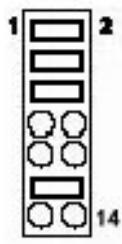
## 5.6 Serial port COM3 mode select (JCOM3)

Jumper group JCOM3 configures the signaling level on the signals of serial port COM3. Three signaling modes are supported for this port: RS-232, RS-422, and RS-485, as indicated below.

| <i>Setting</i>                        | <i>Mode</i> |   |
|---------------------------------------|-------------|---|
| Short (1-2), (13,14) (default)        | RS-232      |    |
| Short (7-8), (9,10), (11,12), (13,14) | RS-422      |    |
| Short (1-2), (3,4), (5,6), (11,12)    | RS-485      |  |

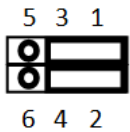
## 5.7 Serial port COM4 mode select (JCOM4)

Jumper group JCOM4 configures the signaling level on the signals of serial port COM4. Three signaling modes are supported for this port: RS-232, RS-422, and RS-485, as indicated below.

| <i>Setting</i>                        | <i>Mode</i> |  |
|---------------------------------------|-------------|--|
| Short (1-2), (13,14) (default)        | RS-232      |   |
| Short (7-8), (9,10), (11,12), (13,14) | RS-422      |   |
| Short (1-2), (3,4), (5,6), (11,12)    | RS-485      |  |

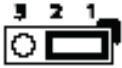
## 5.8 Serial port signals to MXM or Supper I/O (JCOM2)

Jumper group JCOM2 on the PCB, configures serial port signals to COM2 by shorting (1-3), (2-4).



## 5.9 On-board Power Supply Power-up/down Behavior (JPSON1, JPSON2)

Jumper groups JPSON1 and JPSON2 configure the on-board variable input power supply's operating modes. By setting a jumper as shown below, Magellan's AT or ATX power management behavior can be selected.



Following is the AT/ATX jumper combination for a +12V input to Magellan.

| AT/ATX jumper |           | Turning on with Power button | Shut down with power Button | Comment |
|---------------|-----------|------------------------------|-----------------------------|---------|
| JPSON1        | JPSON2    |                              |                             |         |
| 1-2           | 1-2       | yes                          | yes                         | A       |
| 2-3           | 1-2       | No                           | No                          | B       |
| 1-2           | 2-3       | Yes                          | No                          | C       |
| 2-3           | 2-3       | Yes                          | No                          | C       |
| No jumper     | 1-2       | No                           | No                          | D       |
| No jumper     | 2-3       | No                           | No                          | D       |
| 1-2           | No jumper | No                           | yes                         | E       |
| 2-3           | No jumper | No                           | No                          | F       |
| No jumper     | No jumper | No                           | No                          | F       |

**A** - ATX mode

**B** - AT mode

**C** - Power up like ATX

**D** - Won't boot

**E** - Power up like AT, power down with power button and O.S (XP) but baseboard still "ON"

**F** - Power up like AT, power down only in XP, baseboard still "ON"



## 6. BIOS

### 6.1 BIOS Functions

Magellan's BIOS provides access to many valuable features. The following sections describe how to enter the BIOS, set up features, and restore the BIOS to its default settings.

### 6.2 Entering the BIOS

The BIOS may be entered during startup by pressing the **DEL** key on an attached keyboard or pressing **F4** if using console redirection. Press the key repeatedly right after power-on or reset until the BIOS screen appears.

After a certain amount of time during startup, the BIOS will ignore the DEL or F4 key. If you wait too long and the system does not respond, simply reset the board (or power down) and try again.

### 6.3 Storing Default BIOS Settings

In order to load the default BIOS settings, turn off the board, put a jumper on JBAT1 pins 2-3 located on the bottom right corner of the board. This will clear CMOS and reset the BIOS to its default state. After three seconds put the jumper back to JBAT1 pins 1-2 and turn the system on. On the first screen after booting up, you will be asked to press **F1** to run SETUP or **F2** to load the defaults.

### 6.4 Setting the Date and Time

The date and time are set in the BIOS. Select **Main** menu, then enter the date and time at the bottom of the screen. This screen also displays the CPU speed and memory capacity of the board.

### 6.5 ISA Bus IRQ Selection

An ISA bus IRQ must be reserved in the BIOS in order for use by the on-board ISA bus circuits (serial ports and data acquisition), or an installed PC/104 module. To reserve an IRQ, go to the **PCIPnP** menu and scroll down to the IRQ list at the bottom. By default, all IRQ lines are available.

### 6.6 Boot Menu

This section contains:

- Boot Settings Configuration
- Boot Device Priority
- Hard Disk Drives
- Removable Drives

In the Boot Device Priority, the first, second and third priority boot devices can be selected from a popup menu by clicking on each option, a list of available devices will show up in this menu and can include a SATA hard disk drive, USB flashdisk, USB FDD/CDROM, or a Network device (if enabled in Boot Settings Configuration Menu).

The device which appears in "*Boot Device Priority*" popup menu is the first drive selected in "*Hard Disk Drives*" menu.

Booting from USB flashdisk or SATA hard disk drive:

- Boot->Hard Disk Drives -> 1<sup>st</sup> Drive (select the device)
- Boot Device Priority -> 1<sup>st</sup> Boot Device -> (select the same device)

In this way, the system will try to boot from the selected device. The same procedure applies for other boot devices.

The removable drive is normally a USB FDD or CDROM which can be enabled / disabled in the related section.

#### Booting from USB FDD

Boot->Removable Device [Enabled] (This applies for USB FDD only)

Boot Device Priority -> 1<sup>st</sup> Boot Device -> (select FDD)

#### Booting from USB CD/DVD

**Note:** for USB CD/DVD drives the “**Removable Device**” option changes to “**CD /DVD Drives**”

Boot->CD/DVD Drives [Enabled] (This applies for CD/DVD drive only)

Boot Device Priority -> 1<sup>st</sup> Boot Device -> (select CD/DVD Drive)

## 6.7 Chipset

The chipset menu defines the North / South Bridge options such as Graphic Adapter Modes, Flat panel type (default 800x600) and enable/disable of board Ethernet adapters. By default both LAN controllers are enabled. This can be changed in the south bridge menu.

## 6.8 Super I/O Configuration

This sets the address/IRQ of the four serial ports. COM3 and COM4 are capable of RS-232/422/485 protocols, whereas COM1 and COM2 are can only be set to RS-232. The protocols are jumper selectable and are not configured in the BIOS.

## 6.9 Console Redirection

In the **Advanced** menu, you can select any of the serial ports for console redirection at different speeds ranging from 9600 to 115200bps.

## 6.10 Power Type Select

Select the AT/ATX mode; the jumpers should also be configured accordingly.

## 6.11 Boot Delay

This will add a five second delay to the boot process in order to provide more time for PCIE devices to get initiated on the board.

## 6.12 Saving the Changes

After applying changes to the BIOS, the system needs five seconds to update the SPI Flash. In the **EXIT** menu, when **Save and exit** is selected, the system will reboot after five seconds.

## 7. WATCHDOG TIMER

One watchdog timer is provided for system control with a WDTO# signal. The watchdog timer has a default hardware setting defined at power on which sets the timer to 10 seconds. The interval also can be programmed by registers for a 10ms, 1s or 1 minute timeout. Upon timeout, the timeout trigger pulls the tri-state signal, WDTO#, low.

### 7.1 Registers

#### CR F5h. (WDTO# and KBC P20 Control Mode Register; Default 00h)

| <i>Bit</i> | <i>Read/Write</i> | <i>Description</i>   |
|------------|-------------------|--|
| 7-5        | Reserved          |  |
| 4          | R/W               | 1000 times faster in WDTO# count mode<br>0: Disable<br>1: Enable<br>(If bit-3 is Second mode, the count mode is 1/1000 sec.)<br>(if bit-3 is Minute mode, the count mode is 1/1000 min.) |
| 3          | R/W               | Select WDTO# count mode<br>0: Second mode<br>1: Minute mode  |
| 2          | R/W               | Enable the rising edge of KBC reset (P20) is issue time-out event<br>0: Disable<br>1: Enable   |
| 1          | R/W               | Disable / Enable the WDTO# output low pulse to the KBRST# pin (pin 60)<br>0: Disable<br>1: Enable  |
| 0          | Reserved          |  |

#### CR F6h. (WDTO# Counter Register; Default 00h)

| <i>Bit</i> | <i>Read/Write</i> | <i>Description</i>  |
|------------|-------------------|---|
| 7-0        | R/W               | Watch dog timer time-out value. Writing a non-zero value to this register causes the counter to load the value to the Watch dog counter and start counting down. If bits 7 and 6 of CR F7h are set, any mouse or keyboard interrupt event will also cause the reload of a previously loaded non-zero value to the Watch dog counter and start counting down. Reading this register returns the current value of the Watch dog counter instead of the Watch dog timer time-out value.<br><br>00h: Time-out disable<br>01h: Time-out occurs after 1 second/minute<br>02h: Time-out occurs after 2 seconds/minutes<br>03h: Time-out occurs after 3 seconds/minutes<br><br>.....<br>FFh: Timer out occurs after 255 seconds/minutes |

**CR F7h. (WDTO# Control and Status Register; Default 00h)**

| <b>Bit</b> | <b>Read/Write</b>    | <b>Description</b>   |
|------------|----------------------|--|
| 7          | R/W                  | Mouse interrupt reset watch dog timer<br>0: Watchdog timer is not affected by mouse interrupt<br>1: Watchdog timer is reset by mouse interrupt       |
| 6          | R/W                  | Mouse interrupt reset watch dog timer<br>0: Watchdog timer is not affected by keyboard interrupt<br>1: Watchdog timer is reset by keyboard interrupt |
| 5          | Write 1 only         | Trigger WDTO# event. This bit is self-clearing.  |
| 4          | R/W<br>Write 0 clear | WDTO# status bit<br>0: Watchdog timer is running<br>1: Watchdog timer issues time-out event  |
| 3-0        | R/W                  | These bits select IRQ resource for WDTO# (02h for SMI# event)  |

## 7.2 Programming Sample Code

Following is sample code for programming Magellan's watchdog timer.

```

/*----- Include Header Area -----*/
#include "math.h"
#include "stdio.h"
#include "dos.h"

/*----- routing, sub-routing -----*/

void main()
{
; W627UHF USE 2E/2F-----

    outportb(0x2e, 0x87);          /* initial IO port */
    outportb(0x2e, 0x87);          /* twice, */

    outportb(0x2e, 0x2B);          /* select CR30 */
    outportb(0x2e+1, 0x00);        /* update CR30 to 01h */

    outportb(0x2e, 0x07);          /* point to logical device */
    outportb(0x2e+1, 0x08);        /* select logical device 8 */
    outportb(0x2e, 0x30);          /* select CR30 */
    outportb(0x2e+1, 0x01);        /* update CR30 to 01h */
    outportb(0x2e, 0xf0);          /* select CRF0 */
    outportb(0x2e+1, 0x00);        /* update CRF0 to 00h */
    outportb(0x2e, 0xf5);          /* select CRF5 */
    outportb(0x2e+1, 0x00);        /* update CRF5 to 00h:sec; 40h:min. */
    outportb(0x2e, 0xf6);          /* select CRF6 */
    outportb(0x2e+1, 0x05);        /* update CRF6 to 05h :5sec */

    outportb(0x2e, 0xAA);          /* stop program W83627HF, Exit */
}

```

## 8. ACCESSORIES

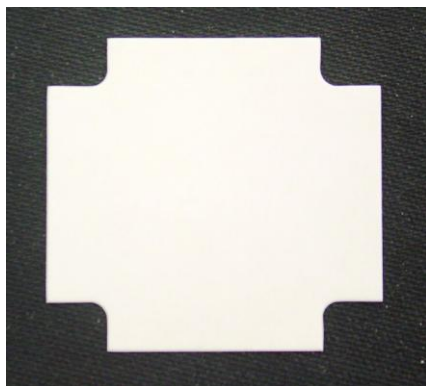
### 8.1 Thermal Pad

A thermal pad is included with every Magellan. It is the same size as the Magellan heatspreader and attaches to the bottom of the heatspreader, but is shipped loose with the product. Customers can choose to affix the thermal pad or not depending on their needs. The specifications for the thermal pad are as follows.

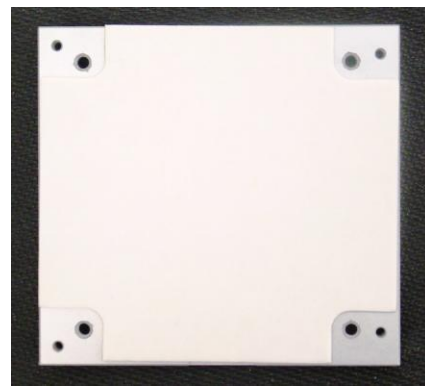
- Material - 3M 5590H
- Color – Light Grey
- Thickness –1.0 mm
- Thermal Conductivity 3.0 W/m-K

To affix the thermal pad:

- Remove the clear plastic film from the adhesive side of thermal pad
- Align the thermal pad above the heatspreader so all four edges are flush with the heatspreader edges and the adhesive side is facing the heatspreader
- Press to attach as shown in the photo below



Thermal pad



Thermal pad on heatspreader

### 8.2 PC/104 Hardware Kit

A PC/104 Hardware Kit ships with Magellan. It has four standoffs that attach on top of the PC/104 standoffs that are on-board, and are needed only when a PC/104 board is added on top of the Magellan SBC. These standoffs are all #4-40 thread and 0.3 inches long.

## 9. SPECIFICATIONS

- Processor: Choice of 1.1GHz Intel Atom Z510 or 1.6GHz Intel Core 2 Duo LV CPU
- Front side bus
  - Atom Z510: 400MHz
  - Core 2 Duo LV: 800MHz
- Memory
  - Atom Z510: 1GB soldered-on DDR2 SDRAM
  - Core 2 Duo LV: 1GB or 4GB SO-DIMM DDR2 SDRAM
- Chipset
  - Atom Z510: US15WPT
  - Core 2 Duo LV: 965GME with ICH8M
- BIOS: AMI PnP Flash BIOS
- Mass storage
  - 1 SATA port, supports 1 device
  - USB flashdisk socket
- Serial ports
  - 2 RS-232 ports
  - 2 RS-232/422/485 ports
- USB ports: 4 USB 2.0
- Networking
  - 1 gigabit Ethernet from COM CPU
  - 1 gigabit Ethernet from Intel 82574 controller on baseboard
- Display
  - LVDS LCD flat panel interface
  - VGA CRT
- Keyboard/Mouse: USB keyboard and mouse
- Audio AC'97 audio CODEC; mic in, line in/out
- Watchdog timer: Non-maskable interrupt or reset modes
- Other I/O SMBus; LPC interface
- Expansion buses
  - PCI-104 or SUMIT stackable expansion
  - FeaturePak™ socket
- On-board power supply
  - +7-36V DC/DC power supply or
  - +12V input only
- Power input: +12VDC or +7-36VDC
- Power consumption
  - MAG-Z510-1G: 10.3W idle, 14.2W loaded
  - MAG-965 models: 14.2W idle, 23.5W loaded
- Operating temperature: MAG-965-xG models: -40°C to +80° (-40°F to +176°F)  
All other models: -40°C to +85° (-40°F to +185°F)
- Operating humidity: 0-90% non-condensing
- MTBF
  - Magellan I/O baseboard: 231,771 hours
  - CME-965 COM: 220,975 hours
  - CME-Z510 COM: 217,416 hours
- Dimensions (L x W x H)
  - MAG-Z510-1G: 4.9 x 3.7 x 1.77 in. (125 x 95 x 45 mm)
  - MAG-965 models: 4.9 x 3.7 x 2.24 in (125 x 95 x 57 mm)
- Weight
  - MAG-Z510-1G: 11.7oz (332g)
  - MAG-965 models: 19.2oz (544g)
- RoHS Compliant

PCI-104™ is a trademark of the PC/104 Embedded Consortium. SUMIT™ is a trademark of the SFF-SIG.  
All other trademarks are the property of their respective owners.



## 10. APPENDIX A

Appendix A shows the pinouts for the Magellan SBC connectors DIOA1 and DIOB1 when used with Diamond Systems' FeaturePak modules; the FP-DAQ1616 and the FP-GPIO96.

### 10.1 FP-DAQ1616 Pinout

#### 10.1.1 DIOA1: Analog I/O Signals

FeaturePak connector pin no.                      DIOA1 pin number                      FeaturePak connector pin no.

|     |                |    |    |                  |     |
|-----|----------------|----|----|------------------|-----|
| 230 | Vin 0/0+       | 1  | 2  | Vin 8/0-         | 229 |
| 226 | Vin 1/1+       | 3  | 4  | Vin 9/1-         | 225 |
| 222 | Vin 2/2+       | 5  | 6  | Vin 10/2-        | 221 |
| 218 | Vin 3/3+       | 7  | 8  | Vin 11/3-        | 217 |
| 214 | Vin 4/4+       | 9  | 10 | Vin 12/4-        | 213 |
| 210 | Vin 5/5+       | 11 | 12 | Vin 13/5-        | 209 |
| 206 | Vin 6/6+       | 13 | 14 | Vin 14/6-        | 205 |
| 202 | Vin 7/7+       | 15 | 16 | Vin 15/7-        | 201 |
| 198 | Aground (Vin)  | 17 | 18 | Aground (Vin)    | 197 |
| 194 | Vout 0         | 19 | 20 | Vout 8           | 193 |
| 190 | Vout 1         | 21 | 22 | Vout 9           | 189 |
| 186 | Vout 2         | 23 | 24 | Vout 10          | 185 |
| 182 | Vout 3         | 25 | 26 | Vout 11          | 181 |
| 178 | Vout 4         | 27 | 28 | Vout 12          | 177 |
| 174 | Vout 5         | 29 | 30 | Vout 13          | 173 |
| 170 | Vout 6         | 31 | 32 | Vout 14          | 169 |
| 166 | Vout 7         | 33 | 34 | Vout 15          | 165 |
| 162 | Aground (Vout) | 35 | 36 | Aground (Vout)   | 161 |
| 160 | ADTrig         | 37 | 38 | Ctrl0Clk         | 159 |
| 158 | Ctrl1Clk       | 39 | 40 | Ctrl1Out         | 157 |
| 156 | Aux0           | 41 | 42 | Aux1             | 155 |
| 154 | Aux2           | 43 | 44 | Aux3             | 153 |
| 152 | ADGate / Aux4  | 45 | 46 | Aux5 / Ctrl1Gate | 151 |
| 150 | WDTOut / Aux6  | 47 | 48 | Aux7 / WDTIn     | 149 |
| 148 | +3.3V          | 49 | 50 | Dground          | 147 |

| Signal Name           | Definition  |
|-----------------------|---|
| Vin 7/7+ ~ Vin 0/0+   | Analog input channels 7 – 0 in single-ended mode;<br>High side of input channels 7 – 0 in differential mode         |
| Vin 15/7- ~ Vin 8/0-  | Analog input channels 15 – 8 in both single-ended mode;<br>Low side of input channels 7 – 0 in differential mode    |
| Vout 0-15             | Analog output channels 0 – 15   |
| Aground (Vout), (Vin) | Analog ground; used for analog signals only<br>Vout pin is for the analog outputs; Vin pin is for the analog inputs |
| Dground               | Digital ground reference for digital input signals  |
| AD Gate               | Enables A/D sampling when high or open, disables when pulled low  |
| AD Trig               | External A/D trigger or clock input   |

Ctr0Clk, Ctr1Clk      Counter 0/1 optional external clock inputs  
 Ctr1Out                Counter 1 output signal  
 AUX0-7                Auxiliary digital I/O port; bit direction programmable; Line 4-7 have auxiliary functions for A/D gating, counter gating, and watchdog timer.

### 10.1.2 DIOB1: Digital I/O Signals

FeaturePak connector pin no.                      DIOB1 pin number                      FeaturePak connector pin no.

|     |                 |    |    |               |     |
|-----|-----------------|----|----|---------------|-----|
| 140 | DIO A0          | 1  | 2  | DIO A1        | 139 |
| 138 | DIO A2          | 3  | 4  | DIO A3        | 137 |
| 136 | DIO A4          | 5  | 6  | DIO A5        | 135 |
| 134 | DIO A6          | 7  | 8  | DIO A7        | 133 |
| 132 | DIO B0          | 9  | 10 | DIO B1        | 131 |
| 130 | DIO B2          | 11 | 12 | DIO B3        | 129 |
| 128 | DIO B4          | 13 | 14 | DIO B5        | 127 |
| 126 | DIO B6          | 15 | 16 | DIO B7        | 125 |
| 124 | DIO C0          | 17 | 18 | DIO C1        | 123 |
| 122 | DIO C2          | 19 | 20 | DIO C3        | 121 |
| 120 | DIO C4          | 21 | 22 | DIO C5        | 119 |
| 118 | DIO C6          | 23 | 24 | DIO C7        | 117 |
| 116 | DIO D0          | 25 | 26 | DIO D1        | 115 |
| 114 | DIO D2          | 27 | 28 | DIO D3        | 113 |
| 112 | DIO D4          | 29 | 30 | DIO D5        | 111 |
| 110 | DIO D6          | 31 | 32 | DIO D7        | 109 |
| 108 | DIO E0          | 33 | 34 | DIO E1        | 107 |
| 106 | DIO E2          | 35 | 36 | DIO E3        | 105 |
| 104 | DIO E4          | 37 | 38 | DIO E5        | 103 |
| 102 | DIO E6          | 39 | 40 | DIO E7        | 101 |
| 100 | PWM0 / DIO F0   | 41 | 42 | DIO F1 / PWM1 | 99  |
| 98  | PWM2 / DIO F2   | 43 | 44 | DIO F3 / PWM3 | 97  |
| 96  | DIO F4          | 45 | 46 | DIO F5        | 95  |
| 94  | Latch- / DIO F6 | 47 | 48 | DIO F7 / Ack- | 93  |
| 92  | +3.3V           | 49 | 50 | Dground       | 91  |

| Signal Name   | Definition  |
|---------------|---|
| DIO A7-A0     | Digital I/O port A; byte direction programmable   |
| DIO B7-B0     | Digital I/O port B; byte direction programmable   |
| DIO C7-C0     | Digital I/O port C; byte direction programmable   |
| DIO D7-D0     | Digital I/O port D; byte direction programmable   |
| DIO E7-E0     | Digital I/O port E; bit direction programmable  |
| DIO F7-F0     | Digital I/O port F; bit direction programmable  |
| PWM0-3        | Port F signals have auxiliary functions enabled with control registers:<br>32-bit programmable pulse width modulation outputs                           |
| Latch- / Ack- | DIO latch and acknowledge signals to enable DIO with handshaking;<br>Latch- also serves as a digital input signal to drive a user-controlled interrupt. |
| Dground       | Digital ground  |

## 10.2 FP-GPIO96 Pinout

### 10.2.1 DIOA1

FeaturePak connector pin no.                      DIOA1 pin number                      FeaturePak connector pin no.

|     |                    |    |    |                       |     |
|-----|--------------------|----|----|-----------------------|-----|
| 230 | Ctr 0 In / DIO A0  | 1  | 2  | DIO A1 / Ctr 0 Gate   | 229 |
| 226 | Ctr 1 In / DIO A2  | 3  | 4  | DIO A3 / Ctr 1 Gate   | 225 |
| 222 | Ctr 2 In / DIO A4  | 5  | 6  | DIO A5 / Ctr 2 Gate   | 221 |
| 218 | Ctr 3 In / DIO A6  | 7  | 8  | DIO A7 / Ctr 3 Gate   | 217 |
| 214 | Ctr 4 In / DIO B0  | 9  | 10 | DIO B1 / Ctr 4 Gate   | 213 |
| 210 | Ctr 5 In / DIO B2  | 11 | 12 | DIO B3 / Ctr 5 Gate   | 209 |
| 206 | Ctr 6 In / DIO B4  | 13 | 14 | DIO B5 / Ctr 6 Gate   | 205 |
| 202 | Ctr 7 In / DIO B6  | 15 | 16 | DIO B7 / Ctr 7 Gate   | 201 |
| 198 | Ctr 0 Out / DIO C0 | 17 | 18 | DIO C1 / Ctr 1 Out    | 197 |
| 194 | Ctr 2 Out / DIO C2 | 19 | 20 | DIO C3 / Ctr 3 Out    | 193 |
| 190 | Ctr 4 Out / DIO C4 | 21 | 22 | DIO C5 / Ctr 5 Out    | 189 |
| 186 | Ctr 6 Out / DIO C6 | 23 | 24 | DIO C7 / Ctr 7 Out    | 185 |
| 182 | DIO D0             | 25 | 26 | DIO D1                | 181 |
| 178 | DIO D2             | 27 | 28 | DIO D3                | 177 |
| 174 | DIO D4             | 29 | 30 | DIO D5                | 173 |
| 170 | DIO D6             | 31 | 32 | DIO D7                | 169 |
| 166 | DIO E0             | 33 | 34 | DIO E1                | 165 |
| 162 | DIO E2             | 35 | 36 | DIO E3                | 161 |
| 160 | DIO E4             | 37 | 38 | DIO E5                | 159 |
| 158 | DIO E6             | 39 | 40 | DIO E7                | 157 |
| 156 | PWM 0 / DIO F0     | 41 | 42 | DIO F1 / PWM 1        | 155 |
| 154 | PWM 2 / DIO F2     | 43 | 44 | DIO F3 / PWM 3        | 153 |
| 152 | WDT In / DIO F4    | 45 | 46 | DIO F5 / WDT Out      | 151 |
| 150 | DIO F6             | 47 | 48 | DIO F7 / Interrupt In | 149 |
| 148 | +3.3V              | 49 | 50 | Ground                | 147 |

| Signal Name   | Definition  |
|---------------|---|
| DIO A7-A0     | Digital I/O port A  |
| DIO B7-B0     | Digital I/O port B  |
| DIO C7-C0     | Digital I/O port C; also functions as counter/timers 0-1 and PWM 0-1            |
| DIO D7-D0     | Digital I/O port D; also functions as counter/timers 2-3 and PWM 2-3            |
| DIO E7-E0     | Digital I/O port E; also functions as counter/timers 4-5 and interrupt input    |
| DIO F7-F0     | Digital I/O port F; also functions as counter/timers 6-7 and watchdog timer I/O |
| In 1-10       | Counter input signals   |
| Gate 1-10     | Counter gate signals  |
| Out 1-10      | Counter output signals  |
| PWM3-0        | Pulse width modulator outputs   |
| WDTOUT, WDTIN | Watchdog timer I/O signals  |
| Interrupt     | Interrupt input   |
| +3.3V         | 3.3V power from system  |
| Ground        | Digital ground  |

## 10.2.2 DIOB1

FeaturePak connector pin no.                      DIOB1 pin number                      FeaturePak connector pin no.

|     |        |    |    |        |     |
|-----|--------|----|----|--------|-----|
| 140 | DIO G0 | 1  | 2  | DIO G1 | 139 |
| 138 | DIO G2 | 3  | 4  | DIO G3 | 137 |
| 136 | DIO G4 | 5  | 6  | DIO G5 | 135 |
| 134 | DIO G6 | 7  | 8  | DIO G7 | 133 |
| 132 | DIO H0 | 9  | 10 | DIO H1 | 131 |
| 130 | DIO H2 | 11 | 12 | DIO H3 | 129 |
| 128 | DIO H4 | 13 | 14 | DIO H5 | 127 |
| 126 | DIO H6 | 15 | 16 | DIO H7 | 125 |
| 124 | DIO J0 | 17 | 18 | DIO J1 | 123 |
| 122 | DIO J2 | 19 | 20 | DIO J3 | 121 |
| 120 | DIO J4 | 21 | 22 | DIO J5 | 119 |
| 118 | DIO J6 | 23 | 24 | DIO J7 | 117 |
| 116 | DIO K0 | 25 | 26 | DIO K1 | 115 |
| 114 | DIO K2 | 27 | 28 | DIO K3 | 113 |
| 112 | DIO K4 | 29 | 30 | DIO K5 | 111 |
| 110 | DIO K6 | 31 | 32 | DIO K7 | 109 |
| 108 | DIO L0 | 33 | 34 | DIO L1 | 107 |
| 106 | DIO L2 | 35 | 36 | DIO L3 | 105 |
| 104 | DIO L4 | 37 | 38 | DIO L5 | 103 |
| 102 | DIO L6 | 39 | 40 | DIO L7 | 101 |
| 100 | DIO M0 | 41 | 42 | DIO M1 | 99  |
| 98  | DIO M2 | 43 | 44 | DIO M3 | 97  |
| 96  | DIO M4 | 45 | 46 | DIO M5 | 95  |
| 94  | DIO M6 | 47 | 48 | DIO M7 | 93  |
| 92  | +3.3V  | 49 | 50 | Ground | 91  |

### Signal Name

### Definition

|           |   |
|-----------|---|
| DIO G7-G0 | Digital I/O port G; byte direction programmable, buffered |
| DIO H7-H0 | Digital I/O port H; byte direction programmable, buffered |
| DIO J7-J0 | Digital I/O port J; byte direction programmable, buffered |
| DIO K7-K0 | Digital I/O port K; byte direction programmable, buffered |
| DIO L7-L0 | Digital I/O port L; byte direction programmable, buffered |
| DIO M7-M0 | Digital I/O port M; byte direction programmable, buffered |
| +3.3V     | 3.3V power from system                                    |
| Ground    | Digital ground  |